



## AE69-2H

# Scanning Receiver



# AE69-2H Controls and Display

Antenna  
(See "Connecting the Antenna" on Page 12)

Headphone Jack  
Squelch

Volume

Display

Keypad

DC socket  
6 V

Power

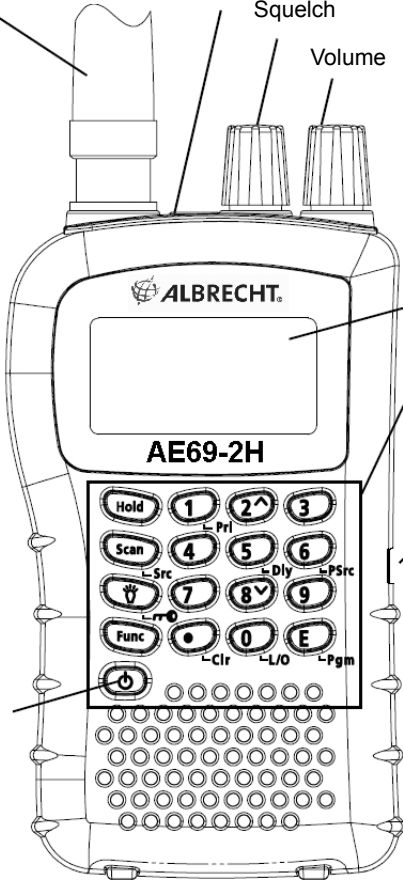

## Contents

AE69-2H Controls and Display .....	2
Introduction .....	4
Precautions .....	4
Earphone Warning .....	4
Safety Warning .....	4
Legal notes: .....	4
Feature Highlights .....	6
About this Manual .....	7
Understanding Scanning .....	7
What is Scanning? .....	7
What is Searching? .....	7
Conventional Scanning .....	7
Simplex Operation .....	8
Repeater Operation .....	8
Where to obtain more Information .....	8
Included with Your Scanner .....	9
Setting Up Your Scanner .....	9
Using different kind of Internal Batteries .....	9
Using Non-Rechargeable Batteries .....	9
Using Rechargeable Batteries .....	10
Using AC Power .....	11
Attaching the Belt Clip .....	12
Connecting the Antenna .....	12
Connecting an optional or outdoor Antenna .....	12
Connecting an Earphone/ ext. Speaker .....	13
Connecting an Extension Speaker .....	13
About Your Scanner .....	13
A Look at the Keypad .....	14
A Look at the Display .....	16
Operation .....	17
Turning the scanner on and setting squelch .....	17
Storing known Frequencies into Channels .....	17
Scanning the Stored Channels .....	17
Manually Selecting a Channel .....	18
Searching for active Frequencies .....	18
Frequency Chain Search .....	18
Chain Search Mode .....	19
Chain Search Hold Mode .....	19
Storing Frequencies Found During Chain Search into Channel Memory .....	19
Setting the Search Range .....	20
Search Skip Memory .....	20
Delay .....	21
Locking Out Channels .....	21
Priority .....	22
Using Keylock .....	22
Using the Display Backlight .....	23
Troubleshooting .....	23
Resetting the Scanner .....	24
Care and Maintenance .....	24
Birdies .....	25
Specifications .....	25
European 2 years warranty .....	26

Where to find service hints and documentation	27
Optional Accessories .....	27
CE-Declaration of Conformity .....	28

## **Introduction**

Thank you for purchasing an Albrecht AE69-2H handheld Scanner. The scanner is versatile, compact, and easy to use. You can program up to 80 frequencies into the scanner's memory. The scanner lets you scan transmissions and is preprogrammed with search ranges for your convenience. You can quickly search those frequencies most commonly used by Amateurs, commercial radio stations, CB, PMR 446 without tedious and complicated programming.

## **Precautions**

Before you use this scanner, please read and observe the following.

## **Earphone Warning**

Use only a recommended Albrecht earphone. An incorrect earphone may be hazardous to your hearing.

Turn down volume before connecting the earphone and then adjust volume to suit.

## **Safety Warning**

Albrecht does not declare this unit to be waterproof. To reduce the risk of fire or electrical shock, do not expose this unit to rain or moisture.

Trademarks used throughout this manual are the property of their respective holders.

## **Legal notes:**

Depending on national regulations, it can be restricted to listen to certain public or private radio services. All users are requested to gather the necessary information about radio services and their protections and privacy. In some countries unauthorized monitoring of transmissions may be even regarded and prosecuted as a crime.

This table lists the frequency ranges, default frequency step and type of transmissions you can hear for each range. The scanner has 3 Band Plans, which are useful for major regions in Europe. Band Plan 2 is optimized for Germany.

<b>Frequency ranges Band Plan 1</b>			
<b>Frequency Range MHz</b>	<b>Steps</b>	<b>Radio Service</b>	
25.0000 - 29.9950	5 kHz	CB, 10 m	
30.0000 - 79.9875	12.5 kHz	VHF Low Band	
80.0000 - 82.9900	10 kHz	VHF Low Band	
83.0000 - 87.2625	12.5 kHz	VHF Low Band	
138.0000 - 157.9875	12.5 kHz	2 m Band	
158.0000 - 160.5900	10 kHz	VHF High Band	
160.6000 - 162.5875	12.5 kHz	VHF High Band	
162.6000 - 173.9900	10 kHz	VHF High Band	
406.0000 - 439.99375	6.25 kHz	70 cm Band	
440.0000 - 465.9950	5 kHz	UHF PMR Band	
466.0000 - 469.9900	10 kHz	UHF PMR Band	
470.0000 - 512.0000	6.25 kHz	UHF "T" Band	

<b>Frequency ranges Band Plan 2</b>			
<b>Frequency Range MHz</b>	<b>Steps</b>	<b>Radio Service</b>	
25.0000 - 84.0100	5 kHz	CB, 10 m, 6m Bands	
84.0150 - 87.2550	20 kHz	4 m Band BOS	
137.0000 - 143.9950	5 kHz	Military VHF radio	
144.0000 - 145.9875	12.5 kHz	2m Amateur Band	
146.0000 - 155.9900	10 kHz	VHF PMR Band	
156.0000 - 162.0250	12.5 kHz	VHF Marine Band	
162.0300 - 173.9900	10 kHz	VHF PMR Band	
406.0000 - 439.99375	6.25 kHz	70 cm Band	
440.0000 - 449.99375	6.25 kHz	PMR incl. PMR 446	
450.0000 - 469.9900	10 kHz	UHF Band PMR	
470.0000 - 512.0000	6.25 kHz	UHF High Band	

<b>Frequency ranges Band Plan 3</b>			
<b>Frequency Range MHz</b>	<b>Steps</b>	<b>Radio Service</b>	
25.0000 - 29.9950	5 kHz	CB, 10 m	
30.0000 - 79.99375	6.25 kHz	VHF Low Band	
80.0000 - 82.99375	6.25 kHz	VHF Low Band	
83.0000 - 87.26250	6.25 kHz	VHF Low Band	
138.0000 - 157.99375	6.25 kHz	2 m Band	
158.0000 - 160.59375	6.25 kHz	VHF High Band	
160.6000 - 162.59375	6.25 kHz	VHF High Band	
162.6000 - 173.99375	6.25 kHz	VHF High Band	
406.0000 - 439.99375	6.25 kHz	70 cm Band	
440.0000 - 465.99375	6.25 kHz	UHF PMR Band	
466.0000 - 469.99375	6.25 kHz	UHF PMR Band	
470.0000 - 512.0000	6.25 kHz	UHF "T" Band	

To switch the band plan between 1,2 and 3:

- Make sure the power is turned off.
- While holding down **1**, **2** or **3** key, turn on the scanner.

**Note:** Please carry out a memory initialization (Reset, see page 23 after band plan was changed).

## Feature Highlights

**Chain Search** - lets you enter personal search bands in 5 locations and search all locations in a chain of frequency bands.

**Triple-Conversion Circuitry** - virtually eliminates any interference from IF (intermediate frequency) images, so you hear only the selected frequency.

**Two-Second Scan Delay** - delays scanning for about 2 seconds before moving to another channel, so you can hear more replies that are made on the same channel.

**Lock-Out Function** - lets you set your scanner to skip over specified channels or frequencies when scanning or searching.

**Priority Channel** - lets you program one channel and then have the scanner check that channel every 2 seconds while it scans, so you do not miss transmissions on this channel.

**Key Lock** - lets you lock the scanner's keys to help prevent accidental changes to the scanner's programming.

**Direct Access** - lets you directly access any channel.

**Display Backlight** - makes the scanner easy to read in low-light situations.

**Flexible Antenna with BNC Connector** – provides adequate reception in strong signal areas and is designed to help prevent antenna breakage. Or, you can connect an external antenna for better reception.

**Memory Backup** - keeps the frequencies stored in memory for an extended time if the scanner loses power.

**Key Confirmation Tones** - the scanner sounds a tone when you perform an operation correctly, and an error tone if you make an error.

**Battery Low Alert** - warns you when battery power gets low.

**Charge and ext. DC** -connector for external 230 V power supply (and charger if NiMH batteries are in use).

## **About this Manual**

The screen displays used in this manual are representations of what might appear when you use your scanner. Since what you see depends on the frequencies for your area and the settings you select, you might notice some differences between what is in this manual and what appears on your scanner.

To get the most from this manual, review the contents to become familiar with the basic functions available. If you are new to scanning, be sure to read the next chapter for a quick background on the technology behind the hobby. The first thing you'll need to do is install batteries in the scanner. Then you need to connect the included antenna to the scanner. See "Using different kind of Batteries" and "Using rechargeable Batteries" on page 9 /10 and "Connecting the Antenna" on page 11 if you need any help doing this.

## **Understanding Scanning**

This section provides you with background on how scanning works. You don't really need to know all of this to use your scanner, but some background knowledge will help you get the most from your AE69-2H.

### **What is Scanning?**

Unlike standard AM or FM radio stations, most two way communications do not transmit continuously. Your AE69-2H scans programmed channels until it finds an active frequency, then stops on that frequency and remains on that channel as long as the transmission continues. When the transmission ends, the scanning cycle resumes until the scanner receives another transmission.

### **What is Searching?**

The AE69-2H can search for active frequencies. This is different from scanning because you are searching for frequencies that have not been programmed into the scanner. When you select frequency bands to search, the scanner searches for any active frequency within the lower and upper limits you specify. When the scanner finds an active frequency, it stops on that frequency as long as the transmission lasts. If you think the frequency is interesting, you can program it into one of the memories. If not, you can continue to search.

### **Conventional Scanning**

Conventional scanning is a relatively simple concept. Each group of users in a conventional system is assigned a single frequency (for simplex systems) or two frequencies (for repeater systems). Any time one of them transmits, their transmission always goes out on the same frequency. Up until the late 1980's this was the primary way that radio systems operated.

Even today, there are many 2-way radio users who operate using a conventional system:

- Aircraft (not to be received with this scanner model)
- Amateur radio
- PMR users

- Broadcast AM/FM/TV stations (not to be received with this scanner model)
- Many other business radio users

When you want to store a conventional system, all you need to know is the frequencies they operate on. When you are scanning a conventional system, the scanner stops very briefly on each channel to see if there is activity. If there isn't, the scanner quickly moves to the next channel. If there is, then the scanner pauses on the transmission until it is over.

### **Simplex Operation**

Simplex systems use a single frequency for both transmit and receive. Most radios using this type of operation are limited to line-of-sight operation. This type of radio is frequently used at construction job sites, and with inexpensive consumer radios such as PMR radios. The range is typically 1.5-12 km, depending upon the terrain and many other factors.

### **Repeater Operation**

Repeater systems use two frequencies: one transmits from the radio to a central repeater; the other transmits from the repeater to other radios in the system. With a repeater-based system, the repeater is located on top of a tall building or on a radio tower that provides great visibility to the area of operation. When a user transmits (on an input frequency), the signal is picked up by the repeater and retransmitted (on an output frequency). The user's radios always listen for activity on the output frequency and transmit on the input frequency. Since the repeater is located very high, there is a very large line of sight. Typical repeater systems provide coverage out to about a 40 km radius from the repeater location.

### **Where to obtain more Information**

By itself, this manual really only provides part of what you need to know to have fun scanning-how to program and use the scanner.

### ***Information on the Internet***

The Internet is a great source for current frequencies and information about scanning.

Many web sites have lists of frequencies for your area. You can use a search engine to find and use them.

Make a list of the agencies you want to listen to, then look up the frequencies and systems used by those agencies.

## Included with Your Scanner

- Owner's Manual
- Scanner and Antenna
- Belt Clip (with 2 screws)

**Note:** If any of these items are missing or damaged, contact your place of purchase.

**Batteries are not included.**

## Setting Up Your Scanner

These guidelines will help you install and use your new scanner:

- If your scanner receives interference or electrical noise, move the scanner or its antenna away from the source.
- To improve the scanner's reception, use an optional external antenna designed for multiband coverage. (You can purchase this type of antenna at a local electronics store). If the optional antenna has no cable, use 50 Ohm coaxial cable for lead-in. A mating plug might be necessary for the optional antennas.
- Use an optional mono earphone or mono headset with proper impedance for private listening. Read the precautions on the inside front cover of this Owners Manual.
- Do not use the scanner in high-moisture environments such as the kitchen or bathroom.
- Avoid placing the scanner in direct sunlight or near heating elements or vents.

## Using different kind of Internal Batteries

You can power your scanner using 2 pcs of Alkaline (standard, non rechargeable), or NiMH (rechargeable) batteries. The size is "Mignon" or "AA", such batteries are available from almost any shop.

## Using Non-Rechargeable Batteries

1. Make sure the power is turned off.
2. Slide the battery compartment cover.
3. Install two fresh batteries in the compartment as indicated by the polarity symbols (+ and -) marked inside.

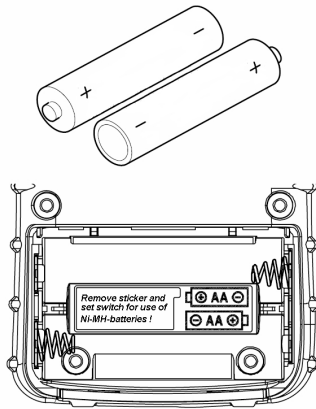

**Cautions:**

- Use only fresh batteries of the required size and recommended type.
- Always remove old or weak batteries. Batteries can leak chemicals that destroy electronic circuits.
- When **BATT** flashes and a beep can be heard every 15 seconds, the battery is empty and you should replace both batteries.
- Do not mix old and new batteries, different types of batteries (standard, alkaline, or rechargeable), or rechargeable batteries of different capacities.

4. Replace the cover.

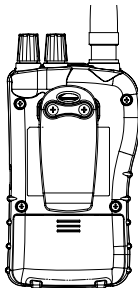

**Using Rechargeable Batteries**

Before you use NiMH batteries the first time, you must charge them. The scanner has a built-in circuit that lets you recharge NiMH batteries while they are inserted in the scanner. Before you can charge such batteries, you must remove the sticker in the battery compartment and move the switch to **Ni-MH BATT.** position. (The default setting of the switch is for regular alkaline batteries **REG.ALK.BATT.**) Then install the batteries in the scanner and connect an optional external AC adapter to the scanner's 6 V socket.

Charge new NiMH batteries, if You use them for the first time,

about 14 hrs to bring them to a full charge.

## **WARNING!**

Do not connect any AC adapter to the scanner if non-rechargeable standard batteries are installed and the switch is still in **NI-MH BATT** position or if you are not sure in which position the switch is. Please make sure that for non-rechargeable batteries the only allowed switch position is **REG.ALK.BATT**. Non rechargeable batteries will get hot and can even burst if you should try to charge them.

### **Notes:**

- NiMH batteries last longer and deliver more power if you occasionally let them fully discharge. To do this, simply use the scanner until it beeps every 15 seconds and **BATT** flashes.
- Do not charge NiMH batteries at temperatures above 45 °C or below 4 °C.
- If you connect an external power source to the scanner please check the switch position of the battery switch. If the switch is set to **REG.ALK.BATT.**, the scanner does not charge the batteries. Rechargeable batteries are only recharged in the **NI-MH BATT.** position of the switch.
- For longer operation, You can also use high capacity NiMH batteries with 2000 mAh or more. Such batteries may need longer charging time. It is very convenient to buy such batteries with a charger as a set, most of them are sold with 4 batteries. So You have always 2 batteries in reserve, and if You need, You can also charge your batteries faster in the external charger.

### **Using AC Power**

You can power the scanner using an optional **6 V DC, 500 mA** wall adapter **AD-671** or equivalent (center pin positive). Adapters, which do not meet these specifications can damage your scanner, the adapter or even the batteries.

Plug the AC adapter into the DC 6 V socket and the AC side into a 230 V wall outlet. If rechargeable batteries are inserted and the battery switch is in **NI-MH BATT**. Position, the adapter powers the scanner and can recharge the batteries at the same time.

## Attaching the Belt Clip

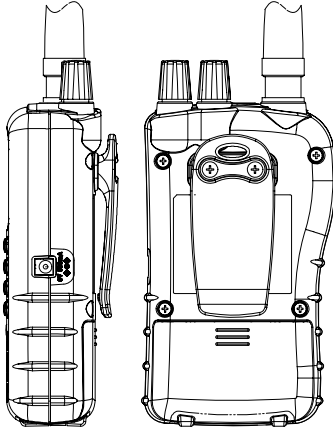

To make your scanner easier to carry when you are on the go, use the supplied belt clip. Use a Phillips screwdriver and the supplied screws to attach the clip to the scanner.

## Connecting the Antenna

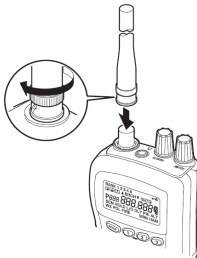

To attach the supplied flexible antenna to the connector on the top of your scanner, align the slots around the antenna's connector with the tabs on the scanner's BNC connector. Then slide the antenna's connector down over the scanner's connector and rotate the antenna connector's outer ring clockwise until it locks into place.

### Connecting an optional or outdoor Antenna

The scanner's BNC connector makes it easy to connect a variety of optional antennas, including an external mobile antenna or outdoor base station antenna.

**Note:** Always use 50-ohm, RG-58, or RG-8, coaxial cable to connect an outdoor antenna. If the antenna is over 15 m from

the scanner, use RG-213/U or "air cell" type low loss coaxial cable. You can get a BNC adapter at your local electronics store.

### Connecting an Earphone/ ext. Speaker

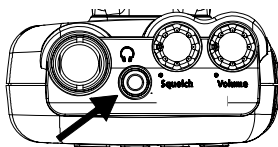

For private listening, you can plug a 3.5 mm mini plug earphone or mono or stereo headphones (not supplied) into the headphone jack on top of your scanner. This automatically disconnects the internal speaker.

### Connecting an Extension Speaker

In a noisy area, an optional extension speaker, positioned in the right place, might provide more comfortable listening. Plug the speaker cable's 3.5- mm mini-plug into your scanner's jack. For larger audio power, active speakers (like used for PC's) are recommended.

### WARNING!

If you connect an external speaker to the scanner's headphone jack, never connect one of the audio output wires to a power supply and /or ground. This might damage the scanner.

### About Your Scanner

We use a few simple terms in this manual to explain the features of the scanner. Familiarize yourself with these terms and the scanner's features, and you can put the scanner to work for you right away. Simply determine the type of communications you want to receive, then set the scanner to scan those communications.

A frequency, expressed in kHz or MHz, is the tuning location of a station. To find active frequencies, you use the search function or refer to a frequency reference.

Besides searching within factory pre-programmed frequency ranges, you can also program Your own frequency ranges and search there. The factory pre-programmed ranges are preset to groups of commonly used frequencies depending on the type of services.

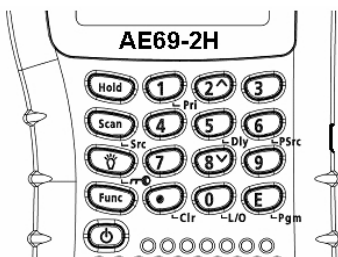

When you search and find a desired frequency, you can store it into a programmable memory location called a channel.

## A Look at the Keypad













Your scanner's keys have various functions labeled on the key tops and below the keys.

To select the function labeled on a key, simply press the key. To select the function labeled below a key:

- First press **Func** then release it.  appears on the display.
- Then press the next key in the function key sequence while  appears.
-  appears or disappears as you press **Func**.

If your scanner's keys seem confusing at first, the following information should help you understand each key's function.

Key Name	Description
<b>Hold</b>	<b>Hold</b> – Holds the scan or the frequency search. Press and hold <b>Hold</b> to increment channels continuously.
<b>Scan/Src</b>	<b>Scan</b> – Scans the stored channels. <b>Func + Src</b> – Starts chain search or resumes searching.
 / 	 turns the display backlight on or off.
<b>Func</b>	<b>Func</b> +  /  locks and unlocks the keypad.
<b>Func</b>	Lets you use various functions by pressing this key in combination with other keys.
	Press and hold for more than 2 seconds to turn the scanner on or off.
<b>1/Pri</b>	<b>1</b> – Enters “1”. <b>Func + Pri</b> – Sets and turns the priority function on or off.

2/ 	2 – Enters “2”. <b>Func + </b> – Selects the search direction.
3	3 – Enters “3”.
4	4 – Enters “4”.
5/Dly	5 – Enters “5”. <b>Func + Dly</b> – Sets and turns the delay function on or off.
6/PSrc	6 – Enters “6”. <b>Func + PSrc</b> – Sets and turns program band select mode on or off.
7	7 – Enters “7”.
8/ 	8 – Enters “8”. <b>Func + </b> – Selects the search direction.
9	9 – Enters “9”.
●/Clr	● – Enters a decimal point “.” <b>Clr</b> – Clears a frequency you entered by mistake.
0/L/O	0 – Enters “0”. <b>Func + L/O</b> – Lets you lock out a selected channel or skip a specified frequency.
E/Pgm	E – Enters frequencies into channels. <b>Func + Pgm</b> – Lets you program the frequency.

## A Look at the Display

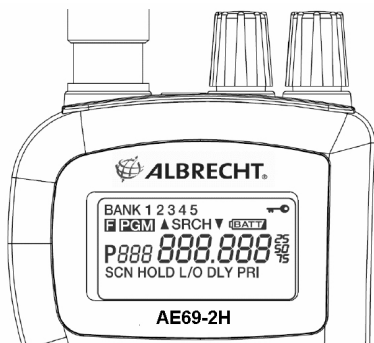

The display has indicators that show the scanner's current operating status. The display information helps you understand how your scanner operates.

**BANK** (search band number) appears with numbers (1-5).

**KT** appears when you lock the keypad.

**F** appears only when the function mode is on.

**PGM** appears while you store a frequency into a channel.

**SRCH** appears during search mode.

**▲** or **▼** appears during search mode.

**BATT** alerts you when the battery power gets low.

**P** appears when you select a priority channel.

**SCN** appears when you scan channels.

**HOLD** appears during scan hold mode and search hold mode.

**L/O** appears when you manually select a channel you locked out or a skip frequency.

**DLY** appears when you select a delay.

**PRI** appears when the priority feature is turned on.

## Operation

### Turning the scanner on and setting squelch

**Note:** Make sure the scanner's antenna is connected before you turn it on.

- Turn **Squelch** fully counterclockwise.
- Press and hold  for about 2 seconds to turn the scanner on.
- Then turn **Volume** clockwise until you hear a hissing sound.
- If the scanner is scanning, press **Hold** to stop scanning, then turn **Squelch** clockwise until the hissing stops.

### Storing known Frequencies into Channels

- (1) Press **Hold**. Then enter the channel number where you want to store a frequency, then press **Func** and **Pgm**. The channel number appears.
- (2) Use the number keys and /Clr to enter the frequency (including the decimal point) you want to store.
- (3) Press **E** to store the frequency into the channel.

#### Notes:

- If you entered an invalid frequency, **Error** appears and the scanner beeps three times. Enter a valid frequency.
- The scanner automatically rounds the entered number to the nearest valid frequency. For example, if you enter 28.473 (MHz), your scanner accepts it as 28.475.
- When you enter a frequency into a channel, the scanner automatically turns on the delay function and **DLY** appears. When delay is turned on, the scanner automatically pauses scanning 2 seconds after the end of a transmission before scanning proceeds to the next channel.
- To turn the function off or on, press **Func + Dly**.
- If you enter a frequency that has already been entered elsewhere, the scanner sounds an error tone and displays the channel that was duplicated. If you entered the frequency by mistake, press **Clr** then enter the correct frequency. To enter the frequency anyway, press **E** to accept.
- To program the next channel in sequence, press **E/ Pgm** and repeat Steps (2) and (3) above.

### Scanning the Stored Channels

To begin scanning channels, press **Scan**. The scanner scans through all non-locked channels. When the scanner finds a transmission, it stops on it. When the transmission ends, the scanner resumes scanning.

## Notes:

- If you have not stored frequencies into any channels, the scanner does not scan.
- If the scanner picks up unwanted partial, or very weak transmissions, turn **Squelch** clockwise to decrease the scanner's sensitivity to these signals. To listen to a weak or distant station, turn **Squelch** counterclockwise.
- To ensure proper scanning, adjust **Squelch** until the audio mutes.

## Manually Selecting a Channel

You can continuously monitor a single channel without scanning. This is useful if you hear an emergency broadcast on a channel and do not want to miss any details - even though there might be periods of silence - or if you want to monitor a specific channel.

- To manually select a channel, press **Hold**, enter the channel number then press **Hold** again.

Or, during scanning, if the radio stops at a channel you want to listen to, press **Hold** once. (Repeatedly pressing **Hold** at this time causes the scanner to step through the channels.) Press **Scan** to resume automatic scanning.

## Searching for active Frequencies

If you do not have a reference to frequencies in your area, use a search to find a transmission.

**Note:** When the scanner starts searching, it automatically turns on the delay function. To turn delay on or off, press **Func + Dly**.

To make the searching process more easy, we have preprogrammed 5 frequency ranges (sometimes called "Search banks"), which can be searched in a "chain" behind each other or "alone" (by excluding ranges from the search).

## Frequency Chain Search

This feature lets you search through preset frequency ranges. You can also change each range to a range you set. There are three modes within this feature: **chain search** mode, **chain search hold** mode, and **program band select** mode. The preset frequency ranges are:

5 Search Bands Band Plan 1		
	Frequency Range MHz	Steps
1	30.0000 - 79.9875	12.5 kHz
2	83.0000 - 87.2625	12.5 kHz
3	160.6000 - 162.5875	12.5 kHz
4	440.0000 - 465.9950	5 kHz
5	466.0000 - 469.9900	10 kHz

5 Search Bands Band Plan 2		
	Frequency Range MHz	Steps
1	84.0150 - 87.2550	20 kHz
2	144.0000 - 145.9875	12.5 kHz
3	156.0000 - 162.0250	12.5 kHz
4	162.0300 - 173.9900	10 kHz
5	406.0000 - 439.99375	6.25 kHz

5 Search Bands Band Plan 3		
	Frequency Range MHz	Steps
1	25.0000 - 29.9950	5 kHz
2	160.6000 - 162.59375	6.25 kHz
3	162.6000 - 173.99375	6.25 kHz
4	440.0000 - 465.99375	6.25 kHz
5	466.0000 - 469.99375	6.25 kHz

To switch the band plan between 1, 2 and 3:

- Make sure the power is turned off.
- While holding down **1**, **2**, or **3**, turn on the scanner.

**Note:** Please carry out a memory initialization (Reset) after band plan was changed. We recommend to change the band plan setting immediately for the correct country setting before first use of the scanner, later, in most cases, changing will be no more necessary.

### Chain Search Mode

Press **Func** + **Src** to start chain search mode. **SRCH**, the enabled **search bank** number, and or (indicating the search direction) appear. The search bank number being searched flashes.

Press **1-5** to enable or disable the search bank number being searched in this mode. Enabled bank numbers appear, while disabled bank numbers disappear.

At least one search bank must be enabled. (The scanner sounds an error tone if you try to disable all the search banks). The search bank and the frequency where chain search starts depends on how the scanner was set before you selected chain search mode.

### Chain Search Hold Mode

To start chain search hold mode, press **Hold** in chain search mode. The scanner stops searching and **HOLD** appears.

- In this mode, pressing **Func** + **▼** changes the search direction downward and pressing **Func** + **▲** changes the search direction upward.
- **▼** or **▲** appears according to the current search direction.

### Storing Frequencies Found During Chain Search into Channel Memory

You can store frequencies you find in chain search mode or

chain search hold mode.

- Press **Func + Pgm** in chain search mode or chain search hold mode. The lowest blank channel appears.
- Press **E + Pgm** to store the frequency into the blank channel. To select another channel, press **Func + ▲** or **Func + ▼** before you press **E / Pgm**.

If you try to save a frequency that is already stored, the scanner sounds an error tone and displays the channel that was duplicated.

- If you entered the frequency by mistake, press **●/Clr**.
- To enter the frequency anyway, press **E** to accept.

The scanner sets itself to program mode after you store a frequency.

### Setting the Search Range

You can use this mode to define the search range used during a search in each search bank.

- To change a search range, press **Func** and **PSrc**. In the display **SRCH** appears.
- Then select a search bank. When you select the search bank, the lower limit and upper limit frequency assigned in the search bank alternate on the display.
- To select another search bank, press **Func + PSrc** or **Func + ▲** to increase the search bank number or **Func + ▼** to decrease it.
- Hold down **Func + ▲** or **Func + ▼** for about 1 second to quickly move through the search bank numbers.

After choosing the search bank, follow these steps to set the lower limit and upper limit frequency.

- Enter the lower limit frequency by using the **0-9** and **●/Clr** keys.
- Press **E** to select the lower limit frequency.
- Enter the upper limit frequency by using the **0-9** and **●/Clr** keys.
- Press **E** to select the upper limit frequency.

### Search Skip Memory

You can skip up to 50 specified frequencies during a search. This lets you avoid unwanted frequencies or those already stored in a channel.

- To skip a frequency, press **Func** and **L/O** when the

scanner stops on the frequency during a search or a search hold.

- The scanner stores the frequency in memory and automatically resumes the search if it is not in hold.

Follow these steps to clear a single frequency from skip memory so the scanner stops on it during a search.

- Press **Hold** to stop the search.
- Press **Func** + ▲ or **Func** + ▼ to select the frequency. **L/O** appears.
- Press **Func** + **L/O**. The **L/O** icon disappears.

To clear all the skip frequencies at once while searching or search hold, press **Func** then press and hold **L/O** until the scanner beeps.

#### Notes:

- If you selected all frequencies to be skipped within the search range, the scanner beeps 3 times and does not search.
- If you select more than 50 frequencies to skip, each new frequency replaces a frequency previously stored, beginning with the first stored frequency.
- Press **Func** + ▲ or **Func** + ▼ to select a skipped frequency while **HOLD** appears. **L/O** appears when you select a skipped frequency.

#### Delay

Sometimes a user might pause before replying to a transmission. To avoid missing a reply on a specific channel, you can program a 2-second delay into any channel or frequency. The scanner continues to monitor the channel frequency for an additional 2 seconds after the transmission stops before resuming scanning or searching. The scanner automatically sets a delay when you store frequencies into channels or when you search frequencies. When the delay feature is on, **DLY** appears. If it is off, follow one of these steps to program a delay depending on how the scanner is operating.

- If the scanner is scanning and stops on an active channel where you want to store a delay, quickly press **Func** + **Dly** before it continues scanning again. **DLY** appears.
- If the desired channel is not selected, manually select the channel, then press **Func** + **Dly**. **DLY** appears.
- If the scanner is searching, press **Func** + **Dly** while the scanner is searching. **DLY** appears and the scanner automatically adds a 2-second delay to every frequency it stops on in that band.
- To turn off the 2-second delay, press **Func** + **Dly** while the scanner is monitoring a channel, scanning, or searching. **DLY** disappears.

#### Locking Out Channels

You can increase the scanning speed by locking out channels

that have a continuous transmission.

- To lock out a channel, manually select the channel, then press **Func** + **L/O**. In the display **L/O** appears.

**Note:** You can still manually select locked-out channels.

- To remove the lockout from a channel, manually select the channel, then press **Func** + **L/O**. Now **L/O** will disappear.
- To unlock all channels, press **Hold** to stop scanning, then press **Func** and press and hold **L/O** until the scanner beeps twice.

### Priority

The priority feature lets you scan through the channels and still not miss important or interesting calls on specific channels. You can program one of the stored channels as priority channel.

If the priority feature is turned on, as the scanner scans the memory, it checks the priority channel for activity every 2 seconds. The scanner automatically designates the first channel as priority channel.

Follow these steps to select a different channel as the priority channel.

- Manually select the channel you want to select as the priority channel.
- Press **Func** + **PGM**, then press **Func** + **Pri**. **P** appears to the left of the selected channel number.
- To turn on the priority feature, press **Func** + **Pri** during scanning. **PRI** appears.

Then the scanner checks the designated priority channel every 2 seconds.

- To turn off the priority feature, press **Func** + **Pri**. **PRI** disappears.

### Using Keylock

Use the scanner's keylock to protect it from accidental program changes. When the scanner's keys are locked, the only controls that operate are

**Scan**, **Func**, **Hold**, ,  and .

To turn on keylock, press **Func** + .  appears.

To turn off keylock, press **Func** + .  disappears.

**Note:** Using keylock does not prevent the scanner from scanning channels.

## Using the Display Backlight

- To turn on the display light for easy viewing at night, press  .

The display lights for 15 seconds.

- To turn off the light sooner, press  again.

## Troubleshooting

If your AE69-2H is not performing properly, try the following steps.

Problem	Possible cause	Suggestion
The scanner doesn't work.	The scanner might not get any power.	Check the batteries. Correct polarity? Clean contacts? Make sure that the AC adapter (if used) is connected correctly to the wall outlet and the scanner. Make sure that 230 V AC power is available at the wall outlet.
Improper reception.	The scanner's antenna might need to be adjusted.	Check the antenna connection or move or reposition the antenna.
		Move the scanner.
		You might be in a remote area that could require an optional multi-band antenna. Check with your dealer or local electronics store.
Scan won't stop.	The squelch might need to be adjusted.	Adjust the squelch threshold. See "Turning On The Scanner and Setting Squelch"
	The antenna might need to be adjusted.	Check the antenna connection.
	One or more channels might be locked out.	Make sure the channels you want to scan are not locked out.
	The channel's frequency might not be stored in memory.	Make sure the channel's frequency is stored in the scanner's memory.
	The channel might not be active.	Wait for a transmission on the channel.
Scan won't start.	You must press <b>Scan</b> to scan.	Press <b>Scan</b> .

	The squelch might need to be adjusted.	Adjust the squelch threshold. See “Turning On The Scanner and Setting Squelch”.
	One or more channels might be locked out.	Make sure the channels you want to scan are not locked out.
	The antenna might need to be adjusted.	Check the antenna connection.

## Resetting the Scanner

If the scanner's display locks up or stops operating properly, you might need to reset the scanner.

**Caution:** This procedure clears all the information you have stored in the scanner. Before you reset the scanner, try turning it off and on to see if it begins working properly. Reset the scanner only when you are sure it is not working properly. After a reset, only the band plan information and the preprogrammed search bands are still memorized in the scanner!

To reset the scanner:

- Turn off the scanner.
- While holding down **2**, **9**, and **Hold**, turn on the scanner. It takes about 3 seconds to initialize and **CLEAR** appears.

## Care and Maintenance

Keep the scanner dry. If it gets wet, wipe it dry immediately. Use and store the scanner only in normal temperature environments. Handle the scanner carefully: do not drop it. Keep the scanner away from dust and dirt, and wipe it with a damp cloth occasionally to keep it looking new.

## General Use

- Turn the scanner off before disconnecting the power.
- Always write down the programmed frequencies in the event of memory loss.
- If memory is lost, simply reprogram each channel. The display shows 000.000 in all channels when there has been a memory loss.
- Always press each button firmly until you hear the entry tone for that key entry.

## Locations, environment

- Do not use the scanner in high-moisture environments such as in bathroom or outdoor if it is raining.
- Avoid placing the unit in direct sunlight or near heating elements or vents.
- If the scanner receives strong interference or electrical

noise, move it or its antenna away from the source of the noise. If possible, a higher elevation might provide better reception.

- Also try changing the height or angle of the antenna.

### **Cleaning**

- Switch off the unit and take out batteries before cleaning.
- Clean the outside of the scanner with a mild detergent.
- To prevent scratches, do not use abrasive cleaners or solvents. Be careful not to rub the LCD window.
- Do not use excessive amounts of water.

### **Repairs**

Do not attempt any repair. The scanner contains no user serviceable parts. Contact the ALAN Customer Service Center phone (+49) (0)6103 9481 30, send an e-mail to **service@alan-germany.de** or take the scanner to a qualified and authorized repair technician.

### **Birdies**

All radios can receive "birdies" (undesired signals). If your scanner stops during Scan mode and no sound is heard, it might be receiving a birdie. Birdies are internally generated signals inherent in the electronics of the receiver.

Press **L/O** to lock out the channel, then press **Scan** to resume scanning.

If you still cannot get satisfactory results while using your scanner or if you want additional information, please contact the **ALAN technical hotline**. The address and phone number are listed in the warranty chapter at the end of this manual.

### **Specifications**

Channels:.....	80
Frequency Range (in MHz) :	see Band Plans
Channel Steps..	5, 6.25, 10, 12.5 and 20 kHz, see page 5
Typical Receiver Sensitivity (SINAD 12 dB)	
25.005 MHz (FM) .....	0.3 $\mu$ V
54.050 MHz (FM) .....	0.3 $\mu$ V
86.275 MHz (FM) .....	0.3 $\mu$ V
138.150 MHz (FM).....	0.3 $\mu$ V
162.400 MHz (FM) .....	0.3 $\mu$ V
173.220 MHz (FM) .....	0.3 $\mu$ V
406.875 MHz (FM).....	0.4 $\mu$ V
453.250 MHz (FM) .....	0.4 $\mu$ V
511.9125 MHz (FM) .....	0.4 $\mu$ V

Operating Temperature:

Normal ..... -20°C to +60°C

Scan Rate: ..... 50 channels per second (max)

Search Rate

Normal .....60 steps per second (max)

Hyper Search..... 180 steps per second (max)

Priority Sampling ..... 2 seconds

Scan Delay: ..... 2 seconds

IF Rejection (at 162.4 MHz) ..... 90 dB

## IF Frequencies

1st IF (25-173.995 MHz).....	380.6050-380.7000 MHz
1st IF (406-512 MHz) .....	380.60625-380.7000 MHz
2nd IF .....	21.3 MHz
3rd IF .....	450 kHz
Audio Output .....	400 mW maximum
Built-in Speaker .....	32 mm diameter, 8 Ohms
.....	(dynamic type)

## Current Drain

Squelched .....	90 mA
Full Output .....	290 mA

## Power Requirements:

- 2 AA Alkaline Batteries (3V DC),
- or 2 AA Rechargeable Ni-MH Batteries (2.4V DC),
- or AC 230 V Adapter (6 V DC, 500 mA)

Antenna: .....	50 ohms (Impedance)
External Antenna:.....	Antenna Jack BNC Type
Ext. Speaker Jack .....	3.5 mm
Size: .....	68mm (W) x 31.5mm (D) x 115mm (H)
Weight: .....	165 g

Features, specifications, and availability of optional accessories are all subject to change without notice.

## European 2 years warranty

The distributor, dealer or retail shop warrants to the original retail purchaser of this product that should this product or any part of it, under normal use and conditions, be proven defective in material or workmanship within 2 years from the date of original purchase, such defect(s) will be repaired or replaced with new or reconditioned product (at the company's option) without charge for parts and repair labor. To obtain repair or replacement within the terms of this warranty, the product is to be delivered with proof of warranty coverage (e.g. dated bill of sale), specification of defect(s), to the distributor, dealer or his authorized repair center.

The Company disclaims liability for communications range of this product. The warranty does not apply to any product or part there of which, in the opinion of the company, has suffered or been damaged through alteration, improper installation, mishandling, misuse, neglect, accident, or by removal or defacement of the factory serial number/bar code label(s). The warranty does not apply to accessory parts or problems caused through not authorized or not recommended accessories like of the units like batteries, external power supplies, external antennas, earphone, speakers, and over voltage caused through external power supplies, light bulbs, broken antennas, broken swivel belt clips, broken or damaged acrylic glass windows and cabinet parts.

Please contact the dealer or person where you have purchased your Albrecht Scanner.

## Where to find service hints and documentation

The complete technical documentation is updated regularly. You can download the latest versions of user manuals, technical documents and conformity declaration, as well as service hints or FAQ's any time from our server under <http://www.hobbyradio.de>

If You should have a problem, please have a look to the service hints or frequently asked questions (FAQ) before you send your Scanner back to the service center.

## Optional Accessories

Albrecht recommends to use following accessories. These are only examples, You will find our whole range of accessory items in our catalogue.

Order No.	Accessory item
6158	Scanner Antenna Albrecht Miniscan
6156	Scanner Antenna Albrecht Maxiscan
61700	Station Antenna Albrecht Allband
7120	Extension Speaker CB 20
71450	Earphone
AD-671	AC Adapter 230 V to 6 V DC, 500 mA

This product is conform to the new European RoHS Directive (2002/95/EC) about the restriction of hazardous substances in electronic items.

## Recycling of Electronic Items

European regulations request that electronic items must be recycled at the end of their life cycle. Please do not dispose this scanner into normal household trash. If You should once do not need Your scanner any more, please give it to the local electronics waste collection station. The industry will recycle electronic items – so You can help to improve our environment.



© Alan Electronics 2006

Daimlerstr. 1 k  
D- 63303 Dreieich

Dovenkamp 11  
D-22952 Lütjensee

[www.albrecht-online.de](http://www.albrecht-online.de)  
[www.alan-electronics.de](http://www.alan-electronics.de)

Service:

Repair inquiries

(+49) 6103 9481 22

Fax

(+49) 6103 9481 60

e-mail

[service@alan-electronics.de](mailto:service@alan-electronics.de)

Download server

[www.hobbyradio.de](http://www.hobbyradio.de)

## CE-Declaration of Conformity



### CE Konformitätserklärung/ Declaration of Conformity



Hiermit wird erklärt, dass unser Produkt / herewith we declare  
that our product  
Empfangsgerät für Funkanwendungen (Scanner)

#### **AE69-2H**

den folgenden europäischen Normen entspricht: / is in  
conformity to following European Standards

**EU-Richtlinien / EU directives 73/23/EEC (LVD); 89/336  
EEC (EMC) and 99/5/EEC (R&TTE)**

**EN 301 489-1, EN 301 489-5, EN 301 489-15 (EMC)  
EN 300 086-2 (PMR Radio)  
EN 301 783-2 (Amateur Radio)  
EN 60 950 (Electrical Safety)  
Lütjensee, 17.11.2006**

.....  
**(Unterschrift/signature)**  
Wolfgang Schnorrenberg  
Alan Electronics GmbH