

User's Guide



Olympian™ Series

8/32/128 Channel VHF-FM Mobile Transceiver

8/32/128 Channel UHF-FM Mobile Transceiver



www.midlandradio.com

FCC RF EXPOSURE COMPLIANCE REQUIREMENTS FOR OCCUPATIONAL USE ONLY

The FCC has adopted a safety standard for human exposure to RF energy. Proper operation of this radio under normal conditions results in user exposure to RF energy below the Occupational Safety and Health Act and Federal Communication Commission limits.

Mandatory Safety Instructions to Installers and Users:

This radio is **NOT** approved for use by the general population in an uncontrolled environment. This radio is restricted to occupational use and work related operations only. Radio operators must have the knowledge to control their exposure conditions and the exposure conditions of bystanders and/or passengers to satisfy the lower exposure limit allowed for General Population.

To comply with FCC RF exposure limits, **DO NOT** operate the transmitter of this mobile radio when a person outside the vehicle is within 36 inches (92 centimeters) of the antenna.

The antenna supplied by the manufacturer or radio dealer must be mounted at a location such that during radio transmission, no person or persons can come closer than the above indicated minimum safe distance to the antenna, i.e. 36 inches. To comply with current FCC RF exposure limits, the antenna must be installed at or exceeding the minimum safe distance stated above, and in accordance with the requirements of the antenna manufacturer or supplier.

Vehicle Installation Instructions:

The antenna used for this transmitter must be mounted on the center of the roof **ONLY** and must be installed in vehicle having the following characteristics in order to prevent bystanders and passengers from being exposed to levels exceeding the limits for General Population/Uncontrolled Exposure environment:

1. All passengers must be sitting under a solid metal roof.
2. Rooftop width must be at least 72 inches (183 centimeters) OR the edges of the physical boundary of the vehicle must be at least 72 inches apart.

DO NOT operate the radio without the proper antenna installed. Do not substitute any antenna for the one supplied or recommended by the manufacturer or radio dealer. The antenna gain must not exceed 0 dBd. By not following the antenna recommendations you may be exposing person(s) to excess radio frequency radiation. You may contact your radio dealer or the manufacturer for further instructions.

DO NOT transmit more than 50% of total radio use time (50% duty cycle). Transmitting for more than 50% of the time can cause FCC RF exposure compliance requirements to be exceeded. This radio is transmitting whenever the TX/Busy indicator is red or the  icon is displayed. Pressing the PTT switch on the side of the microphone normally causes the radio to transmit.

 *The preceding information is provided to make you aware of RF exposure and how to ensure that this radio is operated within FCC RF exposure limits.*

You, as the qualified end-user of this radio device must control the exposure conditions of bystanders to ensure the minimum separation distance, stated above for satisfying FCC RF exposure compliance, is maintained between the antenna and nearby persons. Transmit only when all person(s) are at least the minimum distance from the properly installed, externally mounted antenna.



Contents

Conventions and Symbols in this Book	4
Disclaimer	4
Safety	4
Introduction	6
Radio Models	6
Radio Features	6
Recommended Accessories	8
Radio Controls	8
Front Panel	8
Rear Panel	9
Backlit LCD Details	9
Setup	10
Unpacking	10
Installation	10
Basic Operation	11
Turning the Radio On and Off	11
Channel Selection	11
Bank Selection	11
Receiving Transmissions from Other Radios	12
Transmitting to Other Radios	13
Scanning Channels	14
Editing Your Scan List	17
Programmable Functions	19
Key Assignment Notes	23
Message Display Quick Reference	23
Error Codes	23
Function Codes	24
Specifications	25
Olympian™ Mobile Connectors	26
Warranty Statement	27

Conventions and Symbols in this Book

- ⚡ **This symbol marks a “caution”. Cautions are special notices which you should read and follow carefully to avoid possible damage to your equipment and to avoid potential danger to yourself or other people.**

- ! **This symbol marks an “important point”. Important points are specific instructions which should be followed closely for proper operation.**

- 📄 *This symbol marks a “note”. Notes are hints or tips which offer additional information to help you.*

Disclaimer

Midland Radio Corporation is committed to continuous quality improvements, for this reason specifications may change without prior notice.

Every effort has been made to ensure that the information in this document is complete, accurate, and up-to-date. Midland assumes no responsibility for the results of errors beyond its control. The manufacturer of this equipment also cannot guarantee that changes in the equipment made by unauthorized people will not affect the transceiver's performance or functions.

Safety

Your Olympian™ mobile transceiver has been carefully designed to give you years of safe, reliable performance. As with all electrical equipment, however, there are a few basic precautions you should take to avoid injury to yourself or damage to the radio:

- ⚡ **Read the instructions in this book carefully.** Be sure to save it for future reference.

- ⚡ **Read and follow all warning and instruction labels on the radio itself.**

- ⚡ **Be sure the PTT button is not pressed when you do not need to transmit.**



- ⚡ **Do not operate the radio near unshielded electrical blasting caps or in an explosive atmosphere.**
 - ⚡ **Do not operate the transmitter of any radio unless all RF connectors are secure.**
 - ⚡ **All equipment must be properly grounded for safe operation.**
 - ⚡ **Do not allow children to operate or play with the radio equipment.**
 - ⚡ **Never attempt to disassemble or service the radio yourself.** All equipment should be serviced by a qualified technician. Contact you local dealer or communications coordinator for assistance.
 - ⚡ **It is mandatory that radio installations in vehicles fueled by liquefied petroleum gas conform to the NFPA 58 standard.** National Fire Protection Association Standard, NFPA 58, applies to radio installations in vehicles fueled by liquefied petroleum (LP) gas with the LP gas container in the trunk or other sealed-off space within the interior of the vehicle. This standard requires that:
 1. Any space containing radio equipment shall be isolated by a seal from the space in which the LP gas container and its fittings are located.
 2. Remote (outside) filling connections shall be vented to the outside.
 - ⚡ **Do not allow the antenna to touch or come in very close proximity with the eyes, face, or any exposed body parts while the radio is transmitting.**
- 📄 *The above warning list is not intended to include all hazards that may be encountered when using this radio.*



Introduction

Congratulations! By choosing the Midland Olympian™ mobile transceiver, you have selected a professional grade radio. Its rugged design will provide years of reliable service and its sophisticated software allows many customizable options.

Radio Models

There are six models in the Olympian™ mobile radio line. The models differ only by band of operation and channel capacity.

MO-1008 – 8 channel VHF, 136-174 MHz.

MO-1032 – 32 channel VHF, 136-174 MHz.

MO-1128 – 128 channel VHF, 136-174 MHz.

MO-4008 – 8 channel UHF, 430-470 MHz.

MO-4032 – 32 channel UHF, 430-470 MHz.

MO-4128 – 128 channel UHF, 430-470 MHz.

Radio Features

The Olympian™ series mobile transceiver is a programmable, synthesized radio featuring:

- 45 Watts (UHF)/50 Watts (VHF) transmit power. 5 Watt low power selection available.
- 12.5 KHz and 25 KHz channel spacing programmable per channel.
- 6 programmable buttons. The function of each button is assigned by dealer programming.
- Noise squelch level software programmable *per channel*. The channel squelch level may also be adjusted using a programmable button.
- Flexible scan programming allows for two priority channels to be assigned. Priority scan, priority transmit and priority lookback are programmable. Scan talkback and nuisance delete are available. A scan escape function button may be programmed.



- Easy scan list editing.
- 50 CTCSS tones and 104 DCS codes are programmable per channel. In addition, up to three custom CTCSS tone frequencies may be programmed into the radio.
- A 2-tone decode sequence may be programmed for each channel. Up to 10 sequences are programmable per radio. Each sequence includes setup for individual and group calls.
- A 2-tone call function may be programmed for each channel. One of the 10 available 2-tone sequences may be sent with a programmable button press.
- A busy channel lockout feature is programmable per channel. An override function is available to allow transmission during repeater hangtime.
- A transmit time-out timer may be programmed to limit continuous transmission time. A PTT release and penalty timer are also programmable.
- A public address mode allows the radio and microphone to be used as a public address system when connected to an external public address speaker.
- A talk-around function button may be programmed to allow for repeater talk-around without using an additional channel.
- A programmable emergency mode may be activated by a programmable function button or external foot-switch.
- An external horn output is available to notify you of a call when you're away from the vehicle.
- A password function is available to prevent unauthorized radio operation. When programmed, a four keypress sequence must be entered each time the radio is turned on, in order to operate the radio.





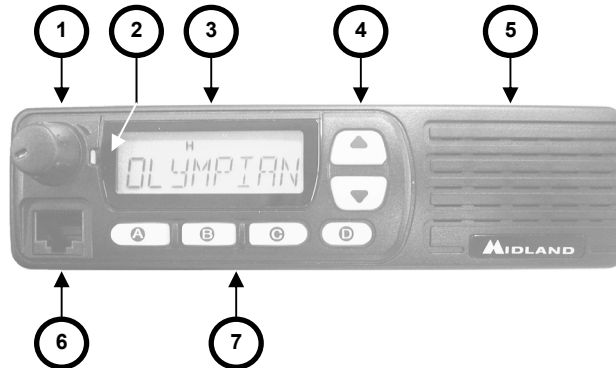

Recommended Accessories

AA-1470A	Remote speaker
ACC-4473	Replacement microphone
ACC-704	Desktop microphone
ACC-709	DTMF microphone

Radio Controls

Front Panel



1. Power/volume knob. Rotate clockwise to turn on the radio. Rotate further clockwise to increase volume.
2. TX/Busy indicator. Lights green when channel is busy and red when radio is transmitting.
3. Backlit LCD display. Provides radio status and channel information.
4.  and  buttons. Programmable function buttons, normally used for channel selection.
5. Internal front speaker.
6. Microphone jack.
7.    and  buttons. Programmable function buttons, dealer customized to provide the features and convenience you require.

Rear Panel

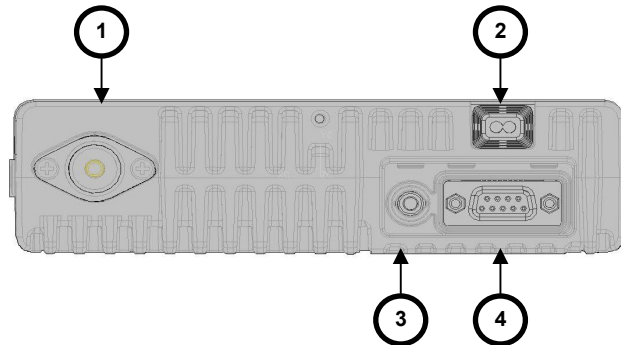

1. SO-239 antenna connector.
2. 13.6 V DC power connector (negative ground only).
3. 3.5 mm mono audio jack for external speaker connection.
4. High density DB15 option interface connector.

Backlit LCD Details

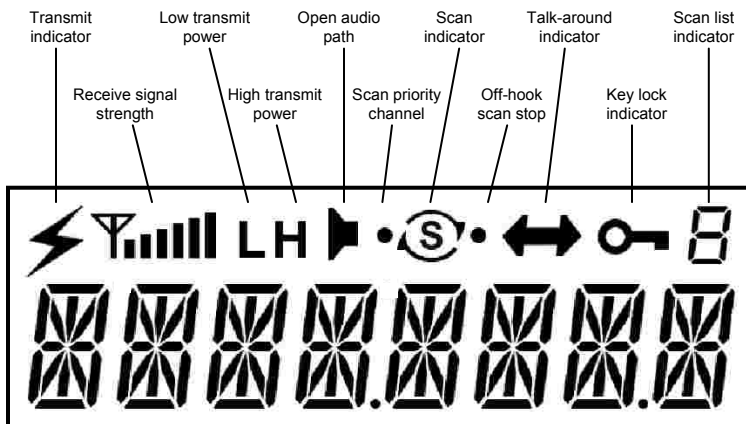



Setup

Unpacking

The following items are supplied in the standard package:

- One transceiver.
- One microphone.
- One DC power cord
- One mounting bracket.
- One mounting hardware package.
- One user's manual.

Installation

Radio installation should only be done by qualified and trained personnel, familiar with automotive electronics installation, and FCC RF exposure guidelines. This transceiver should be installed in 12V negative ground vehicles only. More complete installation instructions are available in the corresponding radio service manual.

Antenna selection, installation and positioning requires knowledge of RF radiation and exposure conditions and should be performed by qualified personnel only. Please consult your dealer or communications coordinator for more information.



Basic Operation

Before turning on your radio for the first time, you should ensure power connections have been made correctly and all antenna connections are proper and secure.

Turning the Radio On and Off

Rotate the power/volume knob clockwise past the detent to turn on the radio. Rotate the power/volume knob further clockwise to increase the volume. Rotate the power/volume knob counterclockwise past the detent to turn off the radio.

If “PP” is displayed after turning on the radio, you must enter the programmed password (4 keypress sequence) to use the radio. Consult your dealer or communications coordinator if you have further questions.

Channel Selection





Use the up and down keys to select the desired operating channel. Please consult your dealer or communications coordinator regarding channels programmed in your radio.

Press and hold the up and down keys to quickly scroll through the available channels.

Bank Selection

Your radio channels may be organized into “banks” or channel groupings that further sort and organize your channels. Please consult your dealer or communications coordinator regarding channel banks programmed in your radio.

To select a different bank of channels press the programmed *Bank* button, then use the up down keys to select the new bank.

Once the desired bank is displayed press the    or  button to select it.



Receiving Transmissions from Other Radios

Each channel of your radio may be programmed for carrier squelch operation, CTCSS/DCS operation or 2-tone operation. The following paragraphs describe these modes of operation. Ask your dealer or communications coordinator if you have questions on how your radio has been programmed to operate.

Carrier Squelch Operation

A signal that matches the programmed receive frequency will be heard if it is of sufficient strength to exceed the squelch threshold. An on frequency signal exceeding the squelch threshold level will be indicated by a steady *green* Tx/Busy indicator.

CTCSS/DCS Operation



CTCSS or DCS signaling adds an additional condition to carrier squelch operation. In addition to the signal having to exceed the squelch threshold level, the received signal must also have the correct CTCSS or DCS tone or code before the audio will be passed to the speaker. CTCSS or DCS signaling allows multiple users on the same frequency to hear only signals which have their correct CTCSS tone or DCS code. An on frequency signal with the correct CTCSS or DCS signaling will be indicated by a steady *green* Tx/Busy indicator. An *amber* Tx/Busy indicator means that the channel is busy, but the correct CTCSS or DCS signaling is not present.

 *CTCSS/DCS allows multiple users to share the same frequency. However CTCSS/DCS is only useful to avoid disturbing other users with messages not related to them. If more than one radio is transmitting at the same time, this will cause interference. Do not transmit if the Tx/Busy indicator is illuminated green or amber. Wait until the channel is clear before transmitting.*



2-tone Operation

2-tone signaling allows individual or group calls to be made to your radio. The radio may have been programmed to mute all receive signals until a 2-tone signal has been decoded. When the programmed 2-tone signal is decoded, the Tx/Busy indicator will blink green, a beep sequence may sound, and subsequent receive audio will be heard over the speaker. The radio may be programmed to mute the speaker again after a programmed time, or you may press and hold the programmed Call Reset function button to mute the radio until it receives a new call.

-  *Consult your dealer or communications coordinator for further details on how your radio has been programmed for 2-tone operation.*
-  *2-tone signaling allows users to receive only calls intended for them. However, more than one radio transmitting at a time will still cause interference. Do not transmit if the Tx/Busy indicator is illuminated green or amber. Wait until the channel is clear before transmitting.*

Transmitting to Other Radios

Before transmitting, the FCC requires you monitor the channel to make sure it is clear. Transmitting while someone else is transmitting will create interference and disrupt both conversations.

Follow these steps to transmit to other radios.

1. Monitor the channel by pressing the programmed function button. Depending on programming the monitor button may disable 2-tone, CTCSS, DCS or noise squelch to allow you to check for channel activity. Channel activity is also indicated by the Tx/Busy indicator.
2. If the channel is clear, press and hold the push to talk (PTT) switch on the side of the microphone.



3. The Tx/Busy indicator will glow red while the radio is transmitting.
4. Hold the microphone approximately 2 inches from your mouth and speak across the face of the microphone in a clear, normal voice.
5. Keep the PTT switch pressed until you have finished speaking.
6. Release the PTT switch to return to receive mode.
 - ☞ *Do not shout! It will only create distortion.*
 - ☞ *Press PTT before you start talking and release PTT after you have finished speaking.*
 - ☞ *Your radio doesn't allow you to talk and receive simultaneously, so keep your transmission short. When you are transmitting, other people can not. Use common sense and do not occupy the channel too much.*
 - ☞ *The radio might be programmed with a **timeout timer** which will automatically end your transmission after a preset time. In this case release PTT and wait for a few seconds. The radio transmitter will be enabled again after a few seconds. Ask your dealer or communications coordinator for further details.*
 - ☞ *The radio might be programmed for **busy channel lock out**, which automatically disables the transmitter if your channel is busy. In this case wait until the channel is clear.*

Scanning Channels

If you have more than one channel programmed, your Olympian™ radio may be programmed to allow you to scan them. To activate scan press and release the programmed function button. The radio will begin checking all channels in the scan list for activity. The scan icon will blink while the radio is scanning. To turn scan off press and release the programmed



function button again. If beeps are enabled a high pitched beep will sound when scan is activated and a lower pitched beep will sound when scan is turned off.

The scan list is initially programmed by your dealer or communications coordinator. Your dealer may also have designated one or two channels in the scan list as a priority channel. The priority channel is checked for activity more often than other channels in the scan list. The priority channel will also be checked for activity while the radio is receiving on a non-priority channel.

Once the receive signal ends, the radio may be programmed to wait a period of time before resuming scan. When the scan *hang timer* has expired, scanning will resume. This scan hang timer will also be started whenever the radio has ceased transmitting on a channel. Your dealer or communications coordinator will customize the scan options for your particular situation; the following paragraphs detail the available options.

Busy Channel Scan

If no priority channel has been assigned by your dealer or communications coordinator, all channels in your scan list will be checked for activity, with no preference given to any channel. If activity is detected on a channel the radio will stop on that channel. While the radio is stopped on a channel it may be temporarily deleted from the scan list by pressing a programmed *Scan Skip* or *Monitor* function button. This is the *nuisance channel delete* function. When the radio is turned off, all channels removed from the scan list using nuisance channel delete will be restored.

Priority Channel Scan

If a priority channel (or two) has been assigned by your dealer or communications coordinator, the priority channel will be checked more often than the other channels in the scan list. If activity is detected on a channel the radio will stop on that channel. While



stopped on a non-priority channel, the radio will continue to check for activity on the priority channel. This is called *priority channel lookback*, and the receive audio from the non-priority channel will be briefly interrupted while priority lookback occurs. While the radio is stopped on a non-priority channel it may be deleted from the scan list by pressing a programmed *Scan Skip* or *Monitor* function button. This is the *nuisance channel delete* function. The priority channel can not be deleted from the scan list. When the radio is turned off, all channels removed from the scan list using nuisance channel delete will be restored.

Priority Select Scan

If *channel select priority* scan has been programmed by your dealer or communications coordinator, the channel selected when scan is turned on will be assigned as the priority channel. Operation will otherwise follow the priority channel scan conventions.

Transmitting While in Scan Mode

If PTT is pressed while the radio is in scan mode, your dealer or communications coordinator may have programmed one of the following options for the transmit channel:

1. When PTT is pressed, the radio will generate an error beep because your dealer or communications coordinator has programmed the radio to not allow transmission while the radio is in scan mode.
2. When PTT is pressed, the radio will switch to and transmit on the priority 1 channel, priority 2 channel or other dealer programmed channel regardless of the current receive state. This mode may be referred to as *priority only transmit*.
3. If the radio has stopped on a channel, or the *scan hang timer* is active, the radio will transmit on the scan stop channel when you press PTT. If you press PTT, while the radio is scanning channels, the radio will switch to and transmit on the priority 1 channel, priority 2 channel or other











dealer programmed channel. This mode may be referred to as *(priority) talkback transmit*.

Editing Your Scan List



One of the advanced features of your Olympian™ mobile radio is the ability to add channels and banks of channels to your scan list. Of course, you may also delete channels and banks of channels from your scan list. These changes are saved in radio EEPROM and are not temporary like *nuisance channel delete*.

The channels in your radio may be organized in banks and each bank may be selected for scan. Then within each bank, each individual channel may be selected for scan. To scan a channel, the channel must be in a bank included in the scan list and the channel must be in the scan list. As you are editing the scan list, if an “e” is shown in the upper right corner of the display, the channel or bank is included in the scan list. If a “D” is shown in the upper right corner of the display, the channel or bank is not in the scan list.





Bank Scan Edit

To add or remove a bank of channels from the scan list, press and hold the *Bank* programmable button for two seconds. Use the  and  keys to select the desired bank. Press the  key to enable (e) or disable (D) the bank for scan. Press the  and  keys to select another bank or press   or  to exit.

Channel Scan Edit

To add or remove a channel in the current bank from the scan list, press and hold the *Scan* programmable button for two seconds. Use the  and  keys to select the desired channel. Press the  key to enable (e) or disable (D) the







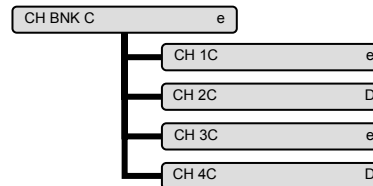
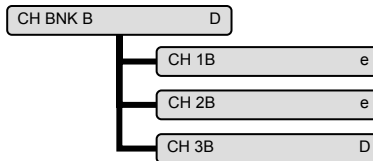
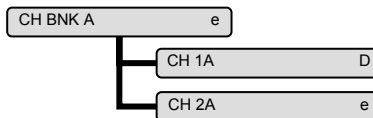

channel in the scan list. Press the  and  keys to select another channel or press ,  or  to exit.







In the example below, channels 2A, 1C and 3C will be scanned. Channels 1B and 2B will not be scanned since channel bank B is disabled from scanning.



Programmable Functions

For increased flexibility and customization, the 6 front panel buttons      and  may be programmed with the following functions:

Bank

Press and release this button to enter bank select mode. Then use the  and  keys to select the desired bank then press    or  to exit. Press and hold this button for two seconds to enter bank scan edit mode.

Call Alert

Press and release this button to enable the horn output. After a 2-tone or DTMF (option) sequence is decoded the horn output will activate as programmed.

-  A decoded call must be reset by a call reset programmable button or the call reset timer, before the horn output can be enabled again.

Call Reset

Press and release this button to mute the radio after a 2-tone sequence or DTMF (option) is decoded.

Call Send

Press and release this button to send the programmed 2-tone or DTMF encode sequence. One of the ten 2-tone or four DTMF (option) sequences can be selected by channel programming.

Channel Up

Press and release this button to increment the radio to the next channel. Press and hold to scroll channels.



Channel Down

Press and release this button to decrement the radio to previous channel. Press and hold to scroll channels.

Emergency

Press and hold this button to activate the emergency function. The programmed emergency response will be performed. After the emergency response is performed, the display will continue to flash "EMER" until another control is used (if emergency display is enabled).

Keylock

Press and hold for one second to lock all other front panel keys. Press and hold again to unlock.

Memory Channel 1 & 2

Press and release the programmed button to switch to the assigned (preset) channel. If allowed by dealer programming, press and hold the programmed function button to assign the current channel as the 1st or 2nd memory channel.

Unsilenced Monitor

Press and release this button to disable 2-tone, DTMF (option), CTCSS, DCS and noise squelch. Once activated, press any button to disable unsilenced monitor mode.

While scan is paused on a channel, press this button to temporarily remove the pause channel from the scan list.

Normal Monitor

Press and release this button to disable 2-tone, DTNF (option), CTCSS and DCS signaling. Once activated, press any button to disable normal monitor mode.

While scan is paused on a channel, press this button to temporarily remove the pause channel from the scan list.



Latched Normal Monitor

Press and release this button to disable 2-tone, DTMF (option), CTCSS and DCS signaling. Once activated, the latched normal monitor remains active until this button is pressed again. This mode must be turned off before scan may be started. While scan is paused on a channel, press this button to temporarily remove the pause channel from the scan list.

Panel Display

Press and release this button to turn off the LCD. Press again to turn the display back on.

Public Address

Press and release this button to activate public address mode. Press again to return to normal radio operation.

Scan

Press and release this button to activate scan. Press again to turn scan off. Press and hold this button for two seconds to enter channel scan edit mode.

Scan Escape

Press and release this button to temporarily suspend scan for communication on the last received channel. Press the *Scan Escape* button again to resume scanning. This function allows you stop scan and communicate on the last received channel, in case you were unable to immediately respond to the call, without affecting your priority channel set-up.

Scan Skip

While scan is paused on a channel, press this button to temporarily delete the pause channel from the scan list. While scan is off, press this button to remove the selected channel from the scan list or add it back if it was previously deleted. The programmed and edited scan list will be restored when the radio is turned off.



Squelch Level

Press and release this button then use the up and down keys to change the noise squelch level for the current channel. The squelch range is 0-16 with 1 being the most sensitive level. Selecting 0 will disable the noise squelch circuit. Press the squelch button again to exit squelch level mode.

Talk Around

Press and release this button to shift the radio transmit frequency to the programmed channel receive frequency. This allows the radio to communicate directly with other radios, which normally communicate through a repeater system. Press again to change back to the programmed transmit frequency.

Tx Power

Press and release this button to toggle the transmit power between the high and low power levels.

Key Assignment Notes

	_____
	_____
	_____
	_____
	_____
	_____

Message Display Quick Reference

Error Codes

Display	Description
NO EEP	No response from EEPROM
PLL ERR	PLL unlock
EEP ERR	EEPROM data error
HI TEMP	Radio high temperature
CLN ERR	Cloning error
DAT ERR	Serial communication error
LOW BAT	Low battery voltage
HIGH BAT	High battery voltage
PASS ERR	Password entry error
TYPE ERR	Incorrect radio model
SET ERR	Radio mode error

**Function Codes**

Display	Description
IND CALL	Individual call
GRP CALL	Group call
ALL CALL	All call
KIL CALL	Kill call
RES CALL	Resurrection call
ANI CALL	ANI start call
NO FUNC	No function assigned to key
NSC ON	Channel restored to scan list
NSC OFF	Channel temporarily removed from scan list
TA ON	Talk around on
TA OFF	Talk around off
SQL 0-15	Current channel squelch level
LOCK ON	Key lock on
LOCK OFF	Key lock off
EMER	Emergency function activated
PA ON	Public address on
PA OFF	Public address off
ALRT ON	Call alert (horn) enabled
ALRT OFF	Call alert (horn) disabled
MCH1-2	Switch to memory channel
MEMCH1-2	Memorize current channel to memory slot
CALL1-4	DTMF call encode
2TONE	2-tone call encode
HKAL ON	Hook alert on
HKAL OFF	Hook alert off
TUNE	Tuning mode
PROG	Programming mode
PASS	Password prompt



Specifications

General specifications	MO-1008/1032/1128 (VHF)	MO-4008/4032/4128 (UHF)
Frequency range	136-174 MHz	430-470 MHz
FCC ID number	MMAMO1032	MMAMO4032
FCC type acceptance	Part 90	Part 90
Maximum number of channels	8/32/128	8/32/128
Maximum number of banks	8	8
Channel spacing	12.5/25 KHz	12.5/25 KHz
Channel stepping	5/6.25/7.5 KHz	5/6.25/7.5 KHz
CTCSS/DCS per channel	50 CTCSS/104 DCS	50 CTCSS/104 DCS
Input voltage	13.6 Vdc ±15%	13.6 Vdc ±15%
MIL spec	810	810
Size (HxWxD)	1.73x6.45x6.38 in (44x164x162 mm)	1.73x6.45x6.38 in (44x164x162 mm)
Weight	3.3 lbs (1.5kg)	3.3 lbs (1.5kg)
EIA/TIA-603 receiver specs		
Frequency stability	±2.5 ppm (-30° to +60° C)	±2.5 ppm (-30° to +60° C)
12 dB SINAD sensitivity	0.25 µV	0.25 µV
Selectivity	70 dB WB/65 dB NB	70 dB WB/65 dB NB
Intermodulation rejection	70 dB WB/65 dB NB	70 dB WB/65 dB NB
Spurious rejection	70 dB WB/65 dB NB	70 dB WB/65 dB NB
Acceptable radio freq displacement	±2 KHz WB/±1 KHz NB	±2 KHz WB/±1 KHz NB
Squelch sensitivity	<12dB Sinad	<12dB Sinad
Audio response	per EIA/TIA-603 specs	per EIA/TIA-603 specs
Audio output	4 Watts <5% THD into 8Ω	4 Watts <5% THD into 8Ω
RF input impedance	50 Ω	50 Ω
EIA/TIA-603 transmitter specs		
RF power output	50 Watts or 5 Watts	45 Watts or 5 Watts
Frequency stability	±2.5 ppm (-30° to +60° C)	±2.5 ppm (-30° to +60° C)
Modulation type	16KOF3E/11KOF3E	16KOF3E/11KOF3E
Adjacent channel emissions	70 dB WB/60 dB NB	70 dB WB/60 dB NB
Spurious emissions	70 dB	70 dB
FM hum & noise	45 dB WB/40 dB NB	45 dB WB/40 dB NB
Audio response	per EIA/TIA-603 specs	per EIA/TIA-603 specs
Audio distortion	<5% 1 KHz @ 60% dev.	<5% 1 KHz @ 60% dev.
RF output impedance	50 Ω	50 Ω

Olympian™ Mobile Connectors

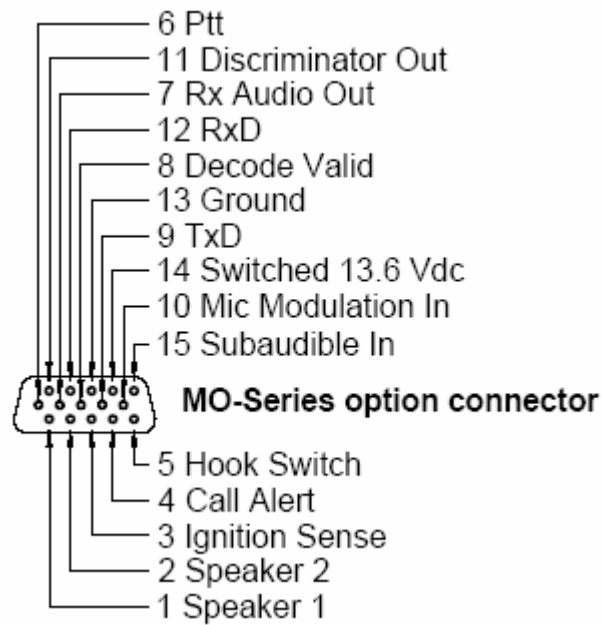
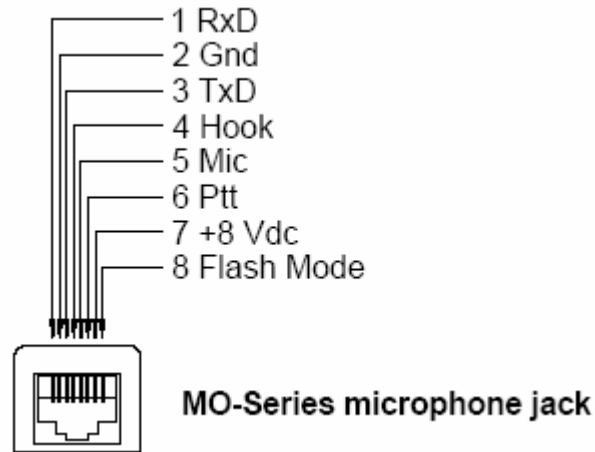



Warranty Statement

Midland Radio Corporation (herein, Midland) warrants each new radio product manufactured or supplied by it to be free from defects in material and workmanship under normal use and service for a period listed below, provided that the user has complied with the requirements stated herein.

The Warranty period begins on the date of purchase from an Authorized Midland Sales and Service Outlet. This Warranty is offered to the original end user and is not assignable or transferable. Midland is not responsible for any ancillary equipment attached to or used in conjunction with Midland products.

Midland offers to the original end user a Two (2) Year Limited Warranty on Midland Business and Industrial radio products. Accessories carry a One (1) Year Limited Warranty.

During this period, if the product fails to function under normal use because of manufacturing defect(s) or workmanship, it should be returned to the Authorized Midland Sales and Service Outlet from which it was purchased. The Sales and Service Outlet will repair the product or return the product for repair to Midland or its Authorized Repair Depot. The user is responsible for the payment of any charges or expenses incurred for the removal of the defective product from the vehicle or other site of its use; for the transportation of the product to the Sales and Service Outlet; for the return of the repaired / replacement product to the site of its use and for the reinstallation of the product.



Midland shall have no obligation to make repairs or to cause replacement required, which results from normal wear and tear or is necessitated in whole or in part by catastrophe, fault or negligence of the user, improper or unauthorized alterations or repairs to the Product, incorrect wiring, use of the Product in a manner for which it was not designed or by causes external to the Product. This Warranty is void if the product serial number is altered, defaced or removed.

Midland's sole obligation hereunder shall be to replace or repair the Product covered in this Warranty. Replacement, at Midland's option, may include a similar or higher-featured product. Repair may include the replacement of parts or boards with functionally equivalent reconditioned or new parts or boards. Replaced parts, accessories, batteries or boards are warranted for the balance of the original time period. All replaced parts, accessories, batteries or boards become the property of Midland.

THE EXPRESS WARRANTIES CONTAINED HEREIN ARE IN LIEU OF ALL OTHER WARRANTIES, EITHER EXPRESSED OR IMPLIED OR STATUTORY, INCLUDING, WITHOUT LIMITATION, ANY WARRANTY OF MERCHANTABILITY OR FITNESS FOR A PARTICULAR PURPOSE.

FOR ANY PRODUCT WHICH DOES NOT COMPLY WITH THE WARRANTY SPECIFIED, THE SOLE REMEDY WILL BE REPAIR OR REPLACEMENT. IN NO EVENT WILL MIDLAND BE LIABLE TO THE BUYER OR ITS CUSTOMERS FOR ANY DAMAGES, INCLUDING ANY SPECIAL, INCIDENTAL, INDIRECT OR CONSEQUENTIAL DAMAGES, OR FOR THE LOSS OF PROFIT, REVENUE OR DATA ARISING OUT OF THE USE OF OR THE INABILITY TO USE THE PRODUCT.

This warranty is void for sales and deliveries outside of the U. S. A. and Canada.

-  ***This device complies with Part 15 of the FCC Rules. Operation is subject to the condition that this device does not cause harmful interference.***
-  ***This radio operates in FCC regulated frequency bands. All radios must be licensed by the FCC before use. Because this radio contains a transmitter, Federal law prohibits unauthorized use or adjustments of this radio.***



Revised June 2005

Printed in Malaysia