

RadioShack®



20-496

PRO-2096 Digital Trunking Mobile/Base Scanner



Please read this user's guide before installing,
setting up and using your new product

www.radioshack.com

Contents

Thank you for purchasing your Pro-2096 digital trunk scanner from RadioShack. You can mount your scanner in a fixed position and use it as a base scanner or you can use it as a mobile scanner by mounting it in a vehicle. This scanner is the first of an innovative and exciting new generation, capable of receiving digital voice modulation from the newest and most sophisticated conventional and trunked radio networks. No additional hardware or add-on cards are needed.

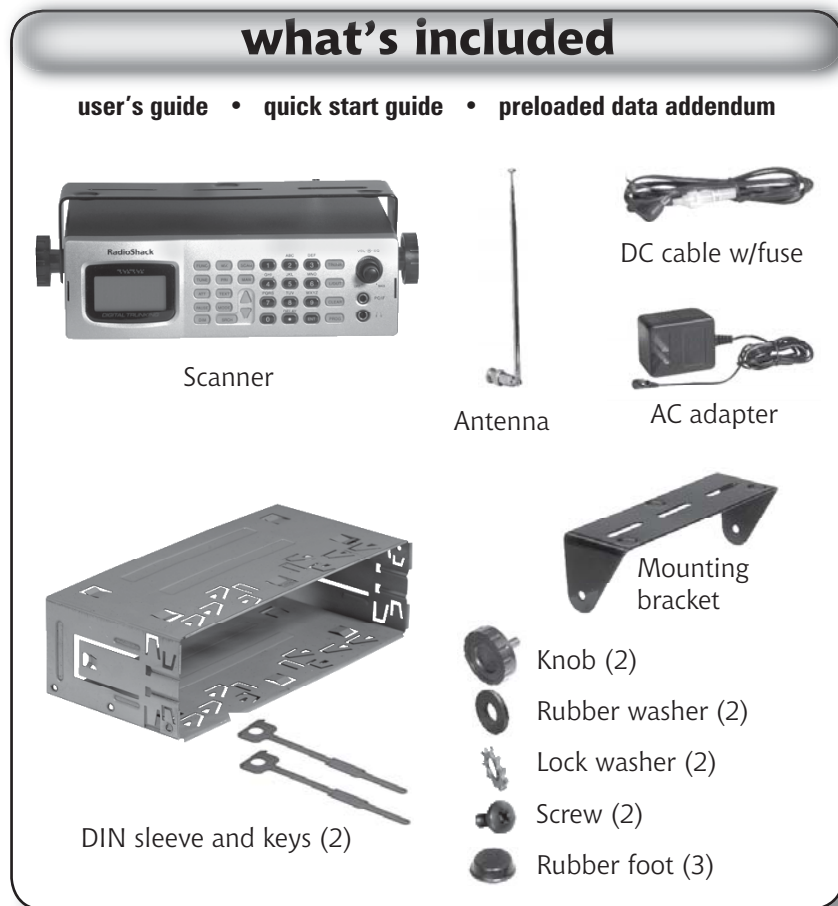

The Basics

contents

your scanner's keypad	7
your scanner's rear view	9
your scanner's display	10
step 1: install your scanner	11
mounting your scanner in your dashboard	11
mobile mounting in your vehicle	11
using your scanner as a base station	12
step 2: power your scanner	13
from a wall outlet	13
through your vehicle's ignition	13
from your vehicle's cigarette lighter	14
step 3: connect your scanner	15
connect the supplied antenna	15
connect an external antenna	15
connect an external speaker or headphones	16
step 4: set up your scanner	17
squelch	17
storing conventional frequencies	17
deleting frequencies from channels	18
searching and tuning	19
basic scanning	20
about channel-storage banks	20
monitoring a single channel	20
using CTCSS and DCS	21
searching a preprogrammed frequency range	21
search bank charts	22

The Basics

searching for active frequencies	27
using Zeromatic	27
using seek search	27
manually tuning to a frequency	28
frequency copy	29
copying a frequency into a specified channel	29
copying a frequency to a vacant channel into a specified bank	30
copying a frequency to the priority channel	30
listening to the weather band	31
same standby mode	31
testing weather alert	32
using delay	33
locking out channels/frequencies	33
locking out channels	33
locking out frequencies	34
reviewing locked-out search frequency	34
clearing locked-out search frequencies	35
clearing locked-out frequencies in search banks	35
changing the receive mode	35
using attenuator	36
global attenuator	37
turning the key tone on or off	37
using the dimmer	38
changing the display contrast	38
virtual scanner	39
using V-scanner	40
using digital AGC	45
cloning programmed data	45
cloning v-scanner data	46
full cloning	47
selective cloning	47

The Basics

trunking operation	50
setting squelch for trunk scanning	50
talkgroup ID hold	50
turning an ID sub-bank on or off	50
open and closed mode operation	51
toggling open and closed modes	52
manual ID lockout toggle	52
activate ID lockout while scanning	53
reviewing locked-out talkgroup IDs	53
changing from ID text tag display	
to ID code display	53
trunked delay function	53
clearing talkgroups IDs	54
clearing all talkgroup IDs in one bank	55
programming trunked systems	56
Motorola analog, digital, and APCO-25 systems	56
EDACS systems	57
Motorola VHF and UHF systems	58
Motorola 800MHz splinter systems	59
fleet maps	59
programming the priority channel	61
programming a stored channel frequency	
in the priority channel	61
programming the priority channel directly	61
programming a weather channel as the priority channel	62
turning priority on or off	62
programming CTCSS/DCS channels	63
storing talkgroup ids	65
text tags	67
assigning a text tag to a channel	67
assigning a text tag to a group ID	68
assigning a text tag to a channel-storage bank	68

The Basics

text input chart	69
using channel receive modes	69
updating the DSP firmware	69
troubleshooting	70
resetting/initializing your scanner	71
resetting your scanner	71
initializing your scanner	72
care	73
replacing the fuse	73
service and repair	73
specifications	74
The FCC wants you to know	77
scanning legally	77
glossary	78
warranty	84

©2004 RadioShack Corporation.
All Rights Reserved.

RadioShack, RadioShack.com, Hypersearch, Hyperscan, V-Scanner, and Adaptaplug are trademarks used by RadioShack Corporation.

Motorola, Smartnet, ASTRO and Privacy Plus are registered trademarks of Motorola Inc.

EDACS is a registered trademark of MA-COM Inc.

The IMBE(TM) Voice Coding Technology embodied in this product is protected by intellectual property rights including patent rights, copyrights and trade secrets of Digital Voice Systems, Inc. This voice coding Technology is licensed solely for use within this Communications Equipment. The user of this Technology is explicitly prohibited from attempting to decompile, reverse engineer, or disassemble the Object Code, or in any other way convert the Object Code into a human readable form.

U.S. Pat. Nos. 5,870,405 and 5,517,511.

This device made under license under one or more of the following U.S. Patents: 4,590,473; 4,636,791; 5,148,482; 5,185,796; 5,271,017; 5,377,229

The Basics

your scanner's keypad



TRUNK — stores the trunking ID code or holds the trunking ID while scanning.

L/OUT — locks out selected channels and ID codes, and skips specified frequencies during a search.

CLEAR — clears an incorrect entry.

PROG — programs frequencies in selected channels.

PWR/VOL/SQ — long knob turns OFF/ON, and controls volume. Short knob controls squelch.

PC/IF — connect data cable for cloning or connecting to a PC.

 — attach headphones with 1/8" jack here.

The Basics

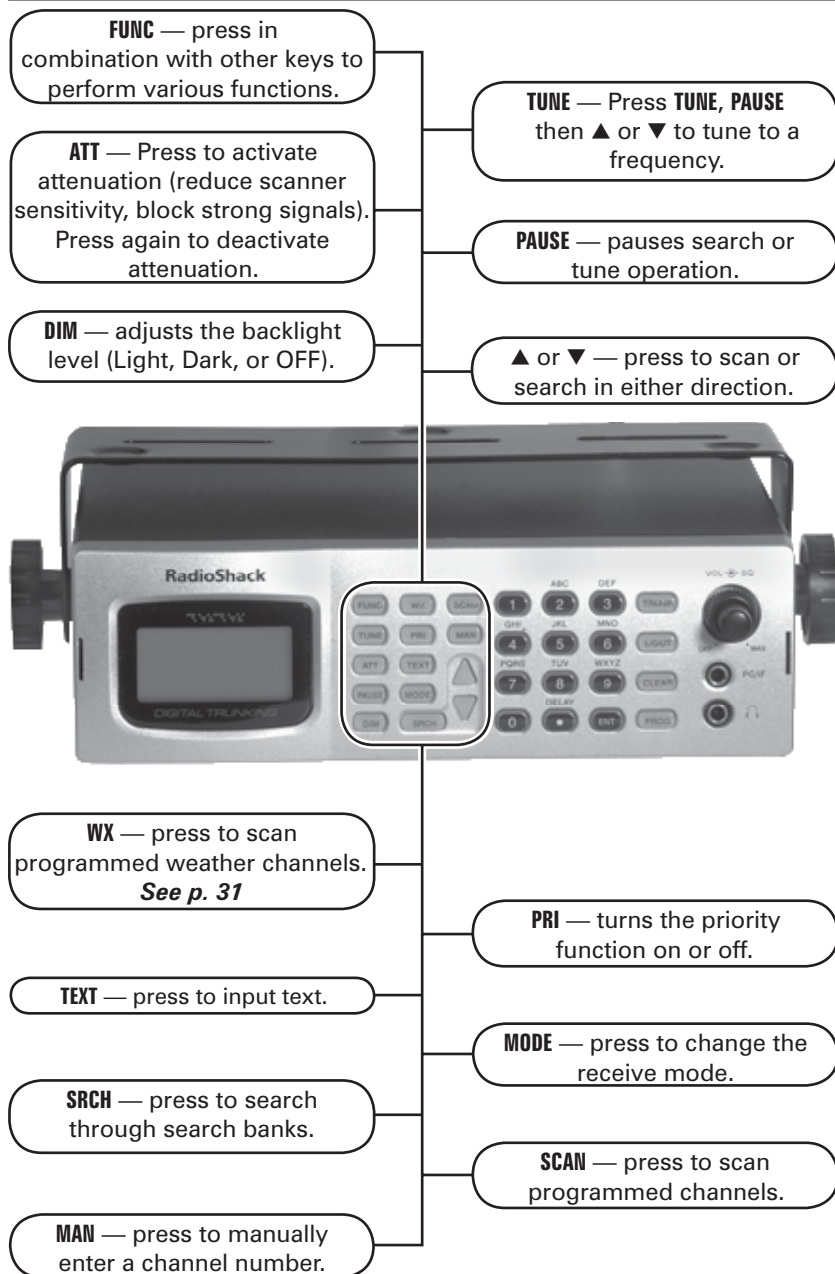

The Basics



Press to enter a number or a character (in text mode).

.DELAY — press to enter a decimal point, space, or hyphen. Press to program delay time for a channel/search bank.

ENT — press to confirm frequency and text entries.

your scanner's rear view



ANT — connect the supplied antenna or an external antenna here.

SCREW HOLE — use to mount the scanner in a car with some hardware (screw not supplied).

EXT SP — connect an external speaker here.

RESET — press to reset your scanner.

DC 13.8V — connect a power source here.

The Basics

your scanner's display

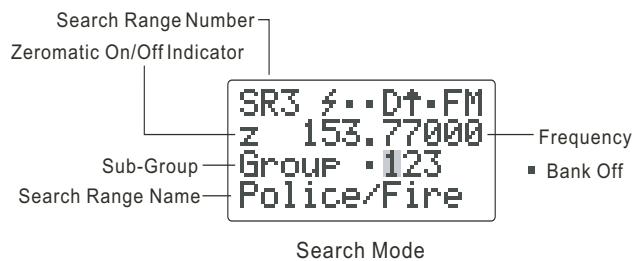
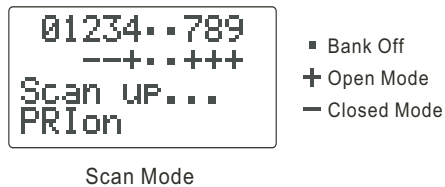
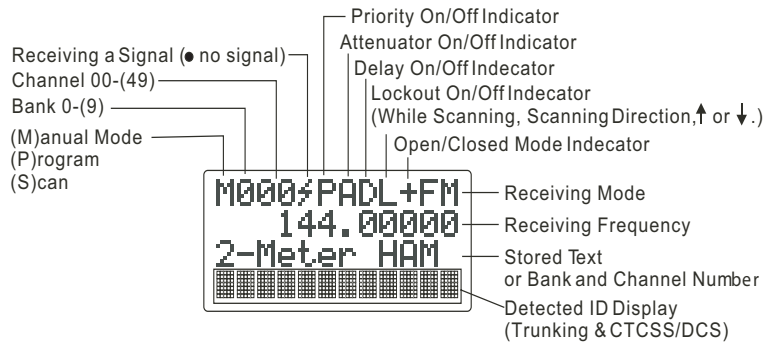

The Basics

step 1: install your scanner

You can mount your digital trunking scanner in your vehicle, install it for mobility, or install it as a base station.

mounting your scanner in your dashboard

If you are unsure about how to install your scanner in your vehicle, consult your automobile manufacturer, dealer, or a qualified installer. Before installing, confirm your scanner fits in the desired mounting area and you have all the necessary materials. Your scanner requires a $2 \times 7\frac{1}{8} \times 5\frac{5}{16}$ inch (50 x 180 x 135 mm) mounting area.

1. Remove the four rear screws and pull off the black case before installing your scanner.
2. Install the DIN sleeve into the opening in your dashboard, lip facing out.
3. Push out the top and bottom tabs to hold the sleeve firmly in place.
4. Slide the scanner into the sleeve until it locks in place.

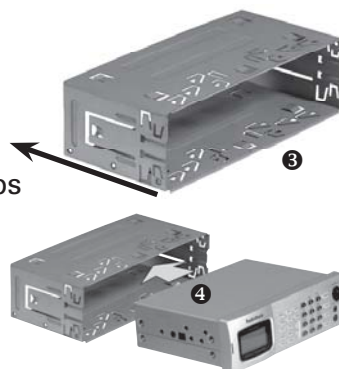

Note

To remove your scanner from the DIN sleeve, insert the two keys straight into the scanner's front panel. Then, remove the scanner by pulling front panel.

Note

When mounting in your dashboard, you will need to connect an external antenna and an external speaker.



mobile mounting in your vehicle

You can mount your scanner under the dashboard, or on top of it, using the mounting bracket.

The Basics

1. Attach the three protective rubber feet to the mounting bracket when you use the scanner on a flat surface. **Do not use them when you mount the bracket with screws.**

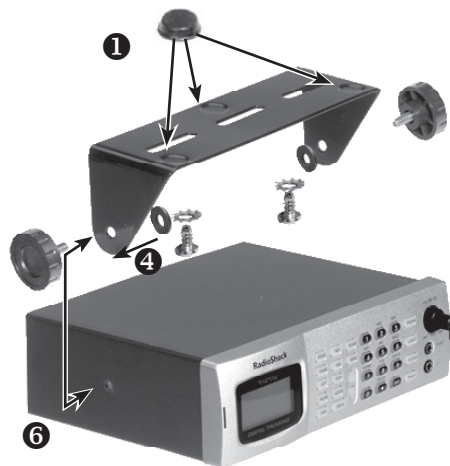

2. Use the supplied mounting bracket as a template to mark positions for the two mounting screws.
3. At the marked positions, drill holes slightly smaller than the screws.
4. Remove the paper backing from each washer and stick one inside of each bracket's ear, aligning the washer's hole with the bracket's hole.
5. Attach the mounting bracket to your vehicle's surface using the supplied screws and lockwashers.
6. Slide the scanner into the bracket, aligning the scanner's holes with the holes in the bracket, and then screw the mounting knobs into the scanner.

Note

When drilling holes, be sure to avoid obstructions behind the mounting surface. Consult a qualified installer if in doubt.

using your scanner as a base station

You can place your scanner on a desk, shelf, or table to use it as a base station. Since the speaker is on the bottom of the scanner, you may want to use the mounting bracket to elevate your scanner off the surface for better sound. Follow the mobile vehicle mounting instructions above to affix your scanner to a desk, shelf, table or other flat surface (except that the bracket will be below the scanner).

The Basics

step 2: power your scanner

You can power your scanner from a wall outlet, through your vehicle's ignition, or from your vehicle's cigarette lighter.

from a wall outlet

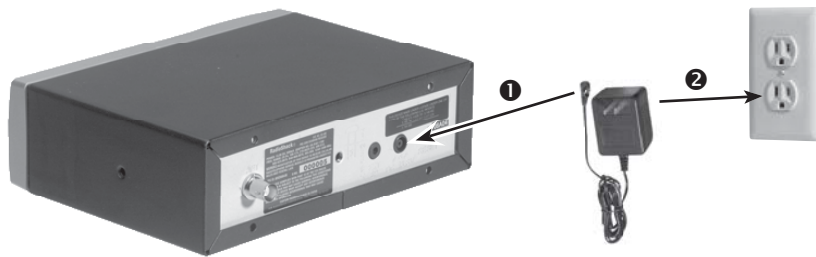

1. Connect the tip of the supplied AC adapter to the DC 13.8V jack at the rear of your scanner.
2. Plug the AC adapter into your wall outlet.

Note

*You must use a Class 2 power source that supplies 13.8V DC and delivers at least 600mA. Its center tip must be set to positive and its plug must fit the scanner's **DC 13.8V** jack. Using an adapter that does not meet these specifications could damage the scanner or the adapter.*

Warning!

To prevent electric shock, do not use the AC adapter's polarized plug with an extension cord, receptacle, or other outlet unless you can fully insert the blades to prevent blade exposure.

through your vehicle's ignition

1. Disconnect the cable from the negative (-) terminal of your vehicle's battery.
2. Ground the black wire of the supplied DC power cord to your vehicle's chassis.



The Basics

Note

Be sure the grounding screw makes complete contact with the metal frame of your vehicle.

3. Connect the red wire of the supplied DC power cord to a voltage source that turns on and off with the ignition switch, such as a spare accessory terminal in your vehicle's fuse box.
4. Insert the power cord's barrel plug into the scanner's **DC 13.8V** jack.
5. Reconnect the cable to the negative (-) terminal of your vehicle's battery.



Rear View

Note

*You must use a power source that supplies 12V DC and delivers at least 600 mA. Its center tip must be set to positive and its plug must fit the scanner's **DC 13.8V** jack. The supplied DC power cord meets these specifications. Using a power cord that does not meet these specifications could damage the scanner or the adapter.*

from your vehicle's cigarette lighter

To power your scanner from a 12V power source in your vehicle, such as a cigarette-lighter socket, you need a 12V, 600 mA DC cigarette-lighter adapter (not supplied), available at your local RadioShack store.

1. Insert the adapter's barrel plug into the scanner's **DC 13.8V** jack.
2. Plug the adapter's other end into your vehicle's cigarette lighter or power socket.

Note

When you use a cigarette-lighter adapter, you might hear electrical noise from your engine while scanning. This is normal.

The Basics

step 3: connect your scanner

connect the supplied antenna

Push the antenna onto your scanner's antenna connector and rotate until it locks into place.

Your scanner's sensitivity to various frequencies depends on its location and the antenna's length. For best reception, adjust the antenna's length as follows:



Frequency	Antenna Length
25-54 MHz	Extend fully
108-174 MHz	Extend 4 segments
216-225 MHz	Extend 3 segments
406-1300 MHz	Collapse fully

connect an external antenna

You will need to connect an external antenna when you mount your scanner in the dashboard of your vehicle. You may also want to connect an external antenna if you use your scanner as a base station.

Your local RadioShack store sells a variety of antennas. Always use 50-ohm coaxial cable, such as RG-58 or RG-8, to connect an outdoor antenna. For lengths exceeding 50 feet, use RG-8 low-loss dielectric coaxial cable. If your coaxial cable does not have a BNC connector, you will also need a BNC adapter (not supplied).



The Basics

Warning!

Use extreme caution when installing or removing an outdoor antenna. If the antenna starts to fall, let it go! It could contact overhead power lines. If the antenna touches a power line, touching the antenna, mast, cable, or guy wires can cause electrocution and death. Call the power company to remove the antenna. Do not attempt to do so yourself.

connect an external speaker or headphones

When you mount your scanner in your dashboard, you will need to connect an external speaker or headphones.



Connect headphones here



Connect external speaker here

listening safely

To protect your hearing, follow these guidelines when you use headphones.

- Adjust **VOL** (volume) to its lowest level before putting on headphones. With the headphones on, adjust **VOL** to a comfortable level.
- Avoid increasing the volume once you set it. Over time, your sensitivity to volume decreases, so volume levels that do not cause discomfort might damage your hearing.
- Avoid listening at high volume levels. Prolonged exposure to high volume levels can cause permanent hearing loss.

traffic safety

Do not wear headphones while driving. This can create a traffic hazard and is illegal in some areas. Even though some headphones let you hear outside sounds when you listen at normal levels, they still can present a traffic hazard.

The Basics

step 4: set up your scanner

squelch

1. Rotate **VOL** clockwise to turn on your scanner. *DSP LOADING* and *Welcome To Digital Trunking* appears. In a few seconds, you might hear a hissing sound.
2. Adjust **VOL** to a comfortable listening level.
3. Rotate **SQ** (squelch) fully counterclockwise to **OFF**. Then, rotate **SQ** clockwise until the hissing sound stops.
4. To turn off the scanner, turn **VOL** counterclockwise to **OFF**.

storing conventional frequencies

1. Turn on your scanner and press **PROG**.
2. Select the desired channel storage bank and channel, and then press **PROG**.
3. Use the number keys and **./DELAY** (to enter the decimal point) to enter the frequency you want to store.
4. Press **ENT** to store the frequency.
5. The scanner configures the channels you enter after a two second delay. A *D* appears at the top of the display. If you do not want the scanner to pause before it resumes scanning, press **./DELAY** until *D* no longer appears on the display.
6. To receive conventional frequencies, including AM, FM/Digital, CTCSS and DCS, press **MODE**. For more information on CTCSS and DCS programming, see "Programming CTCSS/DCS channels".
7. If desired, program a text tag for the channel. See "Assigning a Text Tag to a Channel".
8. To program additional channels, press **PROG** or **▲** or **▼** to move to the next channel memory location.

The Basics

Notes

*If you make a mistake entering the frequency, **Invalid Freq** briefly appears.*

*When you store a frequency by pressing **ENT**, your scanner beeps.*

*Press **CLEAR** to backspace and correct a character, or hold down **CLEAR** for about two seconds to clear the entire field and start over.*

*Your scanner automatically rounds the frequency you enter to the nearest valid frequency. For example, if you enter **151.53**, your scanner accepts it as **151.5275**. Reception of the frequency will not be adversely affected.*

*If you enter a frequency that is already stored, an error tone sounds. Dupl.f and the duplicated frequency number appear. Press **CLEAR** and enter another frequency.*

*You can replace any stored frequency by selecting the desired bank and channel, pressing **PROG**, and then entering the new frequency.*

*Press **FUNC**, and then **CLEAR** to erase programmed frequency data.*

deleting frequencies from channels

In certain circumstances you may wish to completely clear the contents of a channel. One example would be to create empty channels in a selected channel storage bank so the frequency copy function has empty channels available for copied frequencies. See "Copying a Frequency to a Vacant Channel into a Specified Bank".

1. Press **PROG**.
2. Use the number keys or ▲ or ▼ to select the frequency you want to delete.
3. Press **FUNC**, and then **CLEAR**. The frequency is cleared, and *0.00000* appears on the display.

The Basics

searching and tuning

You can search for transmissions using the scanner's preprogrammed search banks. The search banks include six preprogrammed search ranges, SR0 to SR5. You can change the search range of Bank SR6 manually by setting the lower and higher ends of the search range.

Notes

You can use the scanner's delay feature while searching. See "Using Delay".

You can set CTCSS or DCS mode when searching any range, except for SR0, SR1, and SR4. The scanner will display detected CTCSS or DCS codes depending on the mode setting. See "Using CTCSS and DCS".

The scanner does not search locked-out frequencies while searching ranges.

*You can use **PAUSE** to temporarily pause searching. The scanner will remain on the frequency that was active when **PAUSE** was pressed until you press **PAUSE** again. You can simply listen to the radio traffic on the paused frequency, or copy the frequency to a channel before resuming your search.*

The Basics

basic scanning

Press **SCAN** to begin scanning channels. The scanner scans through all channels in the active channel storage bank. See "About Channel Storage Banks".

- You must store frequencies into channels before you can scan them. The scanner does not scan through empty channels.
- To change the scanning direction, press ▲ or ▼ while scanning.

about channel-storage banks

- To turn on a channel storage bank, press the number key corresponding to the desired bank until the bank's number appears on the display.
- To turn off a channel storage bank, press the number key corresponding to the desired bank until the bank's number disappears from the display.
- The scanner does not scan channels within a bank you have turned off; however, you can manually select any channel in a storage bank, even if the bank is turned off.
- You cannot turn off all channel storage banks. There must always be at least one active channel storage bank.

monitoring a single channel

You can monitor a single channel by manually navigating to that channel. The scanner will receive transmissions only on that frequency.

Beyond the Basics

using CTCSS and DCS

Your scanner's advanced, DSP-based CTCSS and DCS, decoder allows you to listen only to a frequency group that is of interest to you. Simply specify the group's specific CTCSS or DCS code for a certain frequency. CTCSS and DCS can also help reduce interfering signals that cause your scanner to stop on one channel.

When your scanner stops on a conventional frequency that is configured for CTCSS or DCS, it checks for a match between the transmitted CTCSS or DCS code and the code stored in channel memory. If the transmitted and stored codes match, the scanner stops on the transmission and allows the audio to pass to the speaker. If the codes do not match, the scanner resumes scanning. If the special "search" code is in use, the scanner instantly displays any detected CTCSS code if programmed for CTCSS mode, or DCS code if programmed for DCS code. You can store the detected code into channel memory by pressing **ENT** while the code is displayed.

searching a preprogrammed frequency range

The scanner contains these preprogrammed search ranges, stored in the search bank (SR0-SR6).

Bank	Band
SR0	Marine
SR1	CB
SR2	FRS/GMRS/MURS
SR3	Police/Fire
SR4	Aircraft
SR5	Ham
SR6	Limit search (User configurable)

1. Repeatedly press **SRCH** to select a search bank.

Beyond the Basics

2. In the marine, CB and FRS bands, you can directly select a channel or search through the band. When *M* appears on the left on the second line, you can directly select a channel (see "Search Bank Charts"). Use the numeric keypad to select a specific two-digit channel number (for example, press **1 6** to select Channel 16, or **0 5** to select channel 5). You can also change the channels by pressing **▲** or **▼**.

There are several group banks in the SR3 Police/Fire and SR5 ham bands. You can turn on the groups by pressing the group numbers. For example, to turn on group 0, press **0**.

3. Press **FUNC, SRCH** while *M* appears in SR0, SR1 or SR2. *M* changes to *S*. Then search through the band. To return to the previous mode, press **FUNC, SRCH**.
4. Rotate **SO** clockwise and leave it set to a point just after the hissing sound stops. After two seconds (if the delay feature is on), the received frequency appears and the scanner starts searching.
5. When the scanner finds an active frequency, it stops searching, and resumes when the transmission ends. If delay is programmed with the search range the scanner will pause for a reply before search resumes.

search bank charts

Search bank: SR0 Marine band

Note

For some Marine frequencies, two frequencies are assigned to one channel, for example, 157.000 and 161.600 are assigned to Channel 20.

Beyond the Basics

Receive mode: FM/Digital

Ch.	Frequency (MHz)	Ch.	Frequency (MHz)
01	156.0500	05	156.2500
06	156.3000	07	156.3500
08	156.4000	09	156.4500
10	156.5000	11	156.5500
12	156.6000	13	156.6500
14	156.7000	15	156.7500
16	156.8000	17	156.8500
18	156.9000	19	156.9500
20	157.0000 161.6000	21	157.0500
22	157.1000	23	157.1500
24	157.2000 161.8000	25	157.2500 161.8500
26	157.3000 161.9000	27	157.3500 161.9500
28	157.4000 162.0000	63	157.1750
64	156.2250 160.8250	65	156.2750
66	156.3250	67	156.3750
68	156.4250	69	156.4750
70	156.5250	71	156.5750
72	156.6250	73	156.6750
74	156.7250	77	156.8750
78	156.9250	79	156.9750
80	157.0250	81	157.0750
82	157.1250	83	157.1750
84	157.2250 161.8250	85	157.2750 161.8750

Beyond the Basics

86	157.3250 161.9250	87	157.3750 161.9750
88	157.4250		

Search bank: SR1 CB band

Receive mode: AM

Ch.	Frequency (MHz)	Ch.	Frequency (MHz)
01	26.9650	02	26.9750
03	26.9850	04	27.0050
05	27.0150	06	27.0250
07	27.0350	08	27.0550
09	27.0650	10	27.0750
11	27.0850	12	27.1050
13	27.1150	14	27.1250
15	27.1350	16	27.1550
17	27.1650	18	27.1750
19	27.1850	20	27.2050
21	27.2150	22	27.2250
23	27.2550	24	27.2350
25	27.2450	26	27.2650
27	27.2750	28	27.2850
29	27.2950	30	27.3050
31	27.3150	32	27.3250
33	27.3350	34	27.3450
35	27.3550	36	27.3650
37	27.3750	38	27.3850
39	27.3950	40	27.4050

Search bank: SR2 FRS/GMRS/MURS

Receive Mode: FM/Digital, CT or DC

Beyond the Basics

Ch.	Frequency (MHz)	Ch.	Frequency (MHz)
01	462.5625	02	462.5875
03	462.6125	04	462.6375
05	462.6625	06	462.6875
07	462.7125	08	467.5625
09	467.5875	10	467.6125
11	467.6375	12	467.6625
13	467.6875	14	467.7125
15	462.5500	16	462.5750
17	462.6000	18	462.6250
19	462.6500	20	462.6750
21	462.7000	22	462.7250
23	151.8200	24	151.8800
25	151.9400	26	154.5700
27	154.6000		

Search bank: SR3 Police/Fire band
Receive Mode: FM/Digital, CT or DC

Group	Frequency (MHz)	Step (kHz)
0	33.420 – 33.980	20
	37.020 – 37.420	20
	39.020 – 39.980	20
	42.020 – 42.940	20
	44.620 – 45.860	40
	45.880	
	45.900	
	45.940 – 46.060	40
	46.080 – 46.500	20

Beyond the Basics

1	153.770 – 154.130	60
	154.145 – 154.445	15
	154.650 – 154.950	15
	155.010 – 155.370	60
	155.415 – 155.700	15
	155.730 – 156.210	60
	158.730 – 159.210	60
	166.250	
	170.150	
2	453.0375 – 453.9625	12.5
	458.0375 – 458.9625	12.5
	460.0125 – 460.6375	12.5
	465.0125 – 465.6375	12.5
3	851.0125 – 860.9875	25
	866.0125 – 868.9875	12.5

Search bank: SR4 Aircraft

Receive mode: AM

Frequency (MHz)	Step (kHz)
108.000 – 136.9875	12.5

Search bank: SR5 Ham band

Receive mode: FM/Digital, CT, DC, AM (depends on group)

Group	Frequency (MHz)	Step (kHz)
0	28.0000 – 29.7000	5
1	50.0000 – 54.0000	5
2	144.0000 – 148.0000	5
3	222.0000 – 225.0000	5
4	420.0000 – 450.0000	12.5
5	1240.0000 – 1300.0000	6.25

Beyond the Basics

searching for active frequencies

You can search a specific range of frequencies by programming SR6 with lower and upper frequency limits.

1. Press **PGM, SRCH**. *PSR* (Program Search) appears in the top line and the cursor blinks *L* on the second line for the lower limit frequency.
2. Use the number keys and **.DELAY** to enter the desired lower limit frequency (including the decimal point).
3. Press **ENTER** to set the lower limit frequency. The cursor moves to upper frequency field. If the entered frequency is incorrect, *Invalid Freq* briefly appears in the scanner's display.
4. Enter your desired upper frequency and press **ENTER**.
5. Rotate **SQUELCH** clockwise and leave it set to a point just after the hissing sound stops.
6. Press **SRCH** to start searching. When the scanner finds an active frequency, it stops searching.

using Zeromatic

Zeromatic sets the scanner to automatically tune to the correct center frequency (or the step increment closest to the correct center frequency) during a search. Turn Zeromatic on or off by pressing **FUNC** then **0**. When this feature is turned on, *Zeromatic ON* briefly appears on the display. Then, *z* appears as the first digit on the second line. If the scanner stops on a signal before it reaches the correct center frequency, skip to the correct frequency using **▲** or **▼**. Zeromatic functions only in search banks 3, 4, 5, and 6.

using seek search

While the scanner is searching, press **FUNC, 7** to turn on seek search. *Seek ON* appears on the bottom line. The scanner

Beyond the Basics

stops on each active frequency for five seconds then automatically resumes searching.

- You can copy and save a frequency into a specified bank, channel, or priority channel when the scanner finds an active frequency. See “Frequency Copy” on Page 29 to save the frequency. Frequency copy works only in search banks 1 - 6.
- In the Air and Limit search bands, press **FUNC** then ▲ to start searching up from the lowest frequency or ▼ to start searching down from the highest frequency.
- You can press ▲ or ▼ at any time to change the search direction or resume searching while stopped on an active frequency.
- Use ▲ or ▼ while paused to increment the frequency one step at a time.

manually tuning to a frequency

You can manually set the scanner to move through all receivable frequencies, or select a specific frequency as a starting point.

1. Press **TUNE**. *TUNE*, the current frequency, and **** PAUSED **** appear on the display.
2. Use the number keys to enter the frequency where you want the scanner to start.
3. Press **ENT** to store the frequency. Press ▲ or ▼ to step up or down from the displayed frequency, or press **PAUSE** to begin automatic tuning.
4. Press ▲ or ▼ to change the automatic tuning direction. The scanner stops when it finds an active frequency.

Note

*If you press **PAUSE** while tuning, the scanner stops tuning and ****PAUSED**** appears on the display. Press **PAUSE** again, and the scanner resumes tuning.*

Beyond the Basics

frequency copy

You can copy a frequency into a specified channel, a vacant channel in a specified bank, or a priority channel. This feature lets you easily store frequencies of interest you encounter while searching or tuning. You cannot copy a frequency from the Marine search bands.

copying a frequency into a specified channel

You can copy a frequency into a channel you specify when the scanner stops on that frequency during search mode or when you manually tune it. If a CTCSS or DCS code is detected on the transmission, the scanner copies the detected code into the channel memory as well.

If you try to copy a frequency that is already stored, the scanner sounds a tone after you press **ENT**. *Dupl.f Chxxx* appears at the bottom line. To copy the duplicate frequency anyway, press **ENT**. Otherwise, press **CLEAR** to cancel.

1. Press **FUNC, PROG** when you find a frequency. *Chan Store?* appears on the bottom line. After about one second, the frequency to be copied flashes on the indicator.
2. Press the desired bank number and channel number where you want to store the frequency. The bank and channel number, then the frequency appear. You can repeat this step as needed until you find an acceptable destination channel. After about one second, the frequency to be copied flashes.
3. Press **ENT**. All the conditions, such as receive mode and delay condition, are copied onto the channel. *Chan Store!* briefly appears. The scanner automatically returns to search mode.

Beyond the Basics

copying a frequency to a vacant channel into a specified bank

You can copy a frequency into a vacant channel in a bank you specify when the scanner stops on the frequency during search or tune mode.

If you try to copy a frequency that is already stored, the scanner sounds a tone after you press **ENT**. *Dupl.f Chxxx* appears at the bottom line. To copy the duplicate frequency anyway, press **ENT**. Otherwise, press **CLEAR** to cancel.

1. Press **FUNC**, **ENT** when you find a frequency you want to copy. *Bank9 Store?* appears.
2. To copy the frequency into bank 9, press **ENT**. The scanner stores the frequency in the first available vacant channel in the bank. Otherwise, enter any bank number then press **ENT** to store the frequency in the selected bank. *Chan Store!* appears for two seconds. All the conditions, such as receiving mode and delay condition, are copied on the channel. After about two seconds, the scanner automatically returns to search mode.

copying a frequency to the priority channel

You can copy a frequency into the priority channel (see "Programming the Priority Channel") when the scanner stops on the frequency during Search, Scan, Manual, Tune, or WX mode. Press **FUNC**, **PRI** when the frequency appears. The display flashes twice and the frequency is copied to the priority channel.

Beyond the Basics

listening to the weather band

The FCC (Federal Communications Commission) has allocated channels for use by the National Oceanic and Atmospheric Administration (NOAA). Regulatory agencies in other countries have also allocated channels for use by their weather reporting authorities.

NOAA and your local weather reporting authority broadcast your local forecast and regional weather information on one or more of these channels.

1. To hear your local forecast and regional weather information, press **WX**. Your scanner scans through the weather band, and then stops on the first active weather frequency.
2. Repeatedly press **WX** to find the strongest weather frequency for your location.
3. If necessary, press **ATT** to attenuate a weather channel if it is receiving interference.

same standby mode

The National Weather Service precedes each weather alert with a digitally encoded SAME (Specific Area Message Encoding) signal. Then, a 1050 Hz tone. The SAME signal includes a FIPS (Federal Information Processing Standard) area code, and an event code that corresponds with the type of alert being sent. You can configure your scanner to operate in SAME Standby mode, where it monitors a selected weather radio station for SAME alerts for areas you specify. You can program your scanner with up to 10 FIPS codes for the areas you desire. The National Weather Service maintains a current list of FIPS codes at <http://www.nws.noaa.gov/nwr/>.

1. Repeatedly press **WX** until you identify the weather station

Beyond the Basics

with the strongest signal for your location.

2. Press **FUNC, PROG** to access the FIPS code entry table.
3. Repeatedly press **▲** or **▼** to select the desired FIPS code storage location.
4. Use the numeric keys to enter the desired FIPS code, then press **ENT** to store the code. Press **TEXT** to label the code entry, if desired. Repeat this step for each FIPS code you want to store.
5. Press **L/OUT** to lock out or enable specific FIPS entries.
6. Press **WX** to exit the FIPS code entry table.
 - Press **WX**, then **0-9** to quickly review stored FIPS codes. Press **L/OUT** to toggle lockout status.
 - Your scanner can also detect the 1050 Hz weather alert tone when a weather channel is set as the priority channel and weather priority operation is enabled. In this mode all alerts are received. FIPS settings are ignored.
 - The scanner sounds an alert or beep when it receives the SAME code. If you do not stop the alert (or beep) for five minutes, the alert stops and the scanner beeps every ten seconds. If the scanner receives a new message after five minutes, it sounds the alert or beep. To stop the sound and ready the scanner to receive a new alert signal before the five minute time out, press any key except **DIM**.
7. Press **FUNC, WX** to turn on SAME standby. The scanner monitors the selected weather radio station for alerts with FIPS codes that match the codes you entered in the FIPS entry table. To exit SAME standby, press **FUNC, WX**.

testing weather alert

To test the SAME weather alert alarm, hold down **WX** for

Beyond the Basics

about two seconds while SAME Standby is active. The display indicates the type of message, and the scanner sounds the alarm associated with that type of message. The alarm sound changes automatically every three seconds. Press any key except **DIM** to end the alarm demonstration mode.

using delay

You can configure your conventional, non-trunked channels for a two second delay to avoid missing reply traffic on the same channel. When delay is set for a conventional channel, the scanner will pause for reply traffic before resuming the scan operation. To toggle the delay setting for a channel, press **/DELAY**.

- Delay is automatically set as the default for each channel when you turn on the scanner.
- Delay operates differently when monitoring trunked radio systems. For more information, see “Trunked Delay Function”.

locking out channels/frequencies

You can lock out channels to force the scanner to skip and ignore any traffic while scanning. While searching, you can lock out up to 50 frequencies to skip undesired transmissions.

locking out channels

To lock out a channel while scanning, press **L/OUT** when the scanner stops on the channel.

To lock out a channel manually, select the channel then press **L/OUT** so **L** appears in the scanner’s display.

Beyond the Basics

Note

You can still manually select and monitor locked-out channels.

Note

Locking out a channel with an active trunking control channel will disable monitoring of that trunking system.

To remove the lockout from a channel, manually select the channel and press **L/OUT** so **L** disappears.

To review all locked out channels, press **MAN**. Then, repeatedly press **FUNC**, **L/OUT**. The scanner advances to the next locked out channel each time you press **FUNC**, **L/OUT**.

locking out frequencies

To lock out a frequency during a search, press **L/OUT** when the scanner stops on that frequency. The scanner locks out the frequency and continues searching.

- You can lock out as many as 50 frequencies in each search bank. If you try to lock out more, *Memory full!* appears, and you will be unable to lock out any more frequencies until you clear some. See "Clearing Locked-Out Search Frequencies".
- If you lock out all frequencies in one search bank and only this search bank is activated, *All ranges Locked out!* appears and the scanner will not search.

reviewing locked-out search frequencies

To review the frequencies within a search bank that you locked out:

1. Press **SRCH** to set search mode, and select the desired search bank to review its locked out frequencies.
2. Press **FUNC** and then **L/OUT**. The last locked-out frequency and *Lockout list* appear. Press **▲** or **▼** to scroll through the list. The locked-out number and the total locked-out number also appears as *L/O XX of YY*. (The tenth of twenty

Beyond the Basics

five locked out frequency appear as *L/O 10 of 25*). If the search bank has no locked-out frequencies, *Empty. Lockout list* appears in the scanner's display. Press **SRCH** to cancel reviewing locked-out frequencies.

clearing locked-out search frequencies

To clear a locked-out frequency, select that frequency (see "Reviewing Locked-Out Search Frequencies"), and then press **CLEAR**. If all locked-out frequencies are cleared in a search bank, *Empty. Lockout list* appears.

clearing locked-out frequencies in search banks

1. Press **SRCH**.
2. Select the search bank where you want to clear all locked-out frequencies.
3. Press **FUNC, L/OUT**. *Lockout list* appears.
4. Press **FUNC, 6**. *Confirm list clear? 1=YES Press other key for NO* appears. Press **1** to clear all locked-out frequencies. *List cleared* briefly appears.
5. To cancel clear, press any key other than **1**.

changing the receive mode

The scanner defaults to the commonly used AM or FM/Digital receive mode for each frequency range. The preset mode is correct in most cases; however, some amateur radio transmissions and trunked systems do not operate in the preset mode. If you try to listen to a transmission when the scanner is not set to the correct receive mode, the transmission might sound weak or distorted.

Beyond the Basics

To change the receive mode, repeatedly press **MODE**. The receive mode changes as follows:

AM	configures an AM channel.
FM/DIGITAL	configures an FM/Digital channel.
CT	configures a CTCSS channel.
DC	configures a DCS channel.
MO	configures a MO channel for analog or digital Motorola trunking system channels, or APCO-25 trunking system channels.
ED	configures an ED channel for EDACS trunking system channels.

MO and ED modes are not available when performing service searches, limit searches and the TUNE function.

using attenuator

To reduce interference or noise caused by strong signals, you can reduce the scanner's sensitivity with the attenuator. There are two attenuator modes in your scanner. Normal attenuator mode allows you to set the attenuator on a per-channel basis. Normal mode is useful when individual channels are found to be prone to interference. Global attenuator mode applies attenuation to every channel in the scanner, and overrides any normal mode attenuator settings that you may have entered.

*To assign attenuation to a channel in the scanner, press **ATT** when the scanner is stopped on a channel, or manually navigate to a channel. *A* appears on the top of the display. Press **ATT** again to turn attenuation off.*

*To assign attenuation to a search bank, press **ATT** while searching. Attenuation will be applied to the active search bank, or search group within a search bank. Press **ATT** again to turn attenuation off.*

Beyond the Basics

- The attenuator is very effective at reducing strong signal overload interference when using the scanner in areas close to cellular telephone transmitting facilities.
- If you turn on the attenuator, the scanner might not receive weak signals.
- Activating the normal attenuator mode on a Motorola or APCO Project 25 trunking control channel applies attenuation to all calls received on that trunking system. You can press **ATT** during a trunking call or while manually tuned to a system control channel to toggle attenuation on or off for the trunking system.

global attenuator

1. Press **FUNC, ATT** to set the attenuator to global mode. *Global ATT* appears for two seconds, and then *ATT-* appears.
2. Press **ATT** to activate the attenuator. *ATTon* appears on the bottom of the display. When the scanner stops on a channel, *a* appears on the top of the display.
3. Press **ATT** to toggle global attenuation off. *ATT-* appears on the bottom line of the display while scanning.
4. Press **FUNC** and then **ATT** again to turn off the global attenuation mode. *Normal ATT* appears on the bottom line for about two seconds.

turning the key tone on or off

Each time you press a scanner key, a tone sounds. You can turn the scanner's key tone off or on.

1. To turn the scanner off, turn **VOL OFF/MAX** counterclockwise until it clicks.
2. To turn the scanner on, turn **VOL OFF/MAX** clockwise. *Welcome To Digital Trunking* appears on the display.

Beyond the Basics

3. Press **1** to turn on the key tone while the message is still on the display. Press **2** to turn it off.

using the dimmer

Repeatedly press **DIM** to adjust the brightness of the display backlight to Dark, Light Off, or Light.

changing the display contrast

1. Press **MAN**.
2. Press **FUNC, 9**.
3. Press **▲** or **▼** to adjust the contrast.
4. Press **ENT** to confirm the display contrast level.

Beyond the Basics

virtual scanner

The PRO-2096 V-Scanner (Virtual Scanner) feature allows you to edit, store, recall and use up to eleven full sets of scanner memory profiles. With V-Scanner, it is possible to create separate scanner memory profiles for different areas you visit or for different ways that you use the scanner.

Your scanner contains two types of storage memory. Working memory is the memory that your scanner uses while you are programming, cloning, or using your scanner. V-Scanner memory is the memory that your scanner uses to store saved configurations in V-Scanner folders for later recall and use. Your scanner features ten V-Scanner folders (0-9) for configuration storage. An additional "scratchpad" V-Scanner folder can be accessed with the decimal point (.) key and is indicated in the display with the "#" symbol. The scratchpad folder offers a convenient location to temporarily store the contents of working memory when managing the V-Scanner memory.

Working with V-Scanner folders is much like working with computer application files, such as spreadsheets and word processing documents. Any programming changes you make to the scanner's working memory can be saved to one of the ten V-Scanner folders, or the scratchpad folder. When you save working memory to a V-Scanner folder, all settings contained in working memory are saved, including channels, talkgroups, lockout status, contrast settings, etc. Previously saved V-Scanner folders can be recalled and loaded into working memory. You can also erase the contents of V-Scanner folders, or move the contents of one folder to another using working memory. V-Scanner folder names are stored in Line 4 from the Welcome screen that appears when you first power on the scanner. You can change the contents of line 4 from the current working memory configuration. This information is saved when you store the V-Scanner.

Beyond the Basics

Follow these steps to edit the V-Scanner name stored in Line 4 of the Welcome screen:

1. Press **PROG**.
2. Press **FUNC, TEXT**. The following text appears on the display:

```
P708---D-+CT  
Welcome Ln-4
```

3. Use standard text entry procedures to enter a V-Scanner name, up to 12 characters long. Press **ENT** when finished. Refer to the "Text Input Chart" on Page 69 for more information on text entry.

You can only change the name of a V-Scanner while it is loaded into working memory. It is not possible to change the V-Scanner folder name from the V-Scanner menus. Always press **FUNC, TEXT** while in program mode to assign a V-Scanner folder name to the current working memory. This name will be stored with the V-Scanner when it is saved, and will appear while you are performing V-Scanner operations. If you press **TEXT** while in a V-Scanner operations menu, you will be prompted to use **FUNC,TEXT** while in program mode to assign or change the name of the V-Scanner folder.

using V-scanner

1. Press **PROG**
2. Press **FUNC, PROG**. The following text appears:

```
V-Scanner  
1-SAVE 3-DEL  
2-LOAD S-CLN  
CLR to EXIT
```

3. Select the option that you wish to execute.

Beyond the Basics

4. If you want to save the contents of the scanner's working memory to a V-Scanner folder, press **1**.

*Save to
V-Scanner:
ENTER if YES
CLR to EXIT*

5. Press the number key that corresponds with the V-Scanner folder you wish to save the current configuration to, or press **CLEAR** to return to V-Scanner menu. Your selected folder location and the name of any previously stored V-Scanner appears in the display. For example, assume you are saving to V-Scanner folder 1, and have previously stored a V-Scanner configuration with the name "My V-Scanner" in that location. If you choose V-Scanner Folder 1, the following appears on the display:

*Save to
V-Scanner: 1
ENTER if YES
My V-Scanner*

6. Press **ENT** to accept the choice, another number key to change your selection, or **CLEAR** to abort and return to the V-Scanner menu. The scanner gives you one final opportunity to abort before proceeding:

*Save to
V-Scanner: 1
ENT= CONFIRM
My V-Scanner*

7. Press **ENT** to confirm your choice and proceed with the V-Scanner save operation. While saving, this text appears:

*Saving to
V-Scanner: 1
Please Wait*

The contents of the selected V-Scanner folder will be replaced with your current working memory data.

Beyond the Basics

8. To load the contents of a V-Scanner folder to the scanner's working memory, press **2**. This message appears:

*Load from
V-Scanner:
ENTER if YES
CLR to EXIT*

9. Press the number key that corresponds with the V-Scanner folder you wish to load into the scanner's working memory, or press **CLEAR** to return to the V-Scanner menu. If you select a V-Scanner folder, the scanner will prompt you to verify your choice. For example, if you choose V-Scanner Folder 1, the scanner will display:

*Load from
V-Scanner: 1
ENTER if YES
My V-Scanner*

10. Press **ENT** to accept the choice, another number key to change your selection, or **CLEAR** to abort and return to the V-Scanner menu. The scanner gives you one final opportunity to abort before proceeding:

*Load from
V-Scanner: 1
ENT= CONFIRM
My V-Scanner*

While loading, the scanner will display:

*Loading from
V-Scanner: 1
Please Wait*

11. The contents of the scanner's current working memory will be replaced with the data from the selected V-Scanner folder.

Beyond the Basics

12. To delete the contents of a V-Scanner folder, select **3**. The scanner will display:

Delete

V-Scanner:

ENTER if YES

CLR to EXIT

13. Press the number key that corresponds with the V-Scanner folder you wish to clear, or press **CLEAR** to return to the V-Scanner menu. If you select a V-Scanner folder, the scanner will display the name of the V-Scanner currently stored in that folder, and prompt you to verify your choice. For example, if you choose V-Scanner Folder 1, the scanner will display:

Delete

V-Scanner:

ENTER if YES

My V-Scanner

14. Press **ENT** to accept the choice, another number key to change your selection, or **CLEAR** to abort and return to the V-Scanner menu. The scanner gives you one final opportunity to abort before proceeding:

Delete

V-Scanner: 1

ENT=CONFIRM

My V-Scanner

While the folder is being cleared, the scanner will display:

Clearing

V-Scanner: 1

Please Wait

15. This display appears after each V-Scanner operation. Pressing **ENT** will return to the main V-Scanner menu. Press **CLEAR** to exit the V-Scanner main menu.

Beyond the Basics

*V-Scanner
Operation
Complete
Press ENTER*

16. This display appears if a failure is encountered while performing a V-Scanner operation. Press **ENT** to try again.

*V-Scanner
Operation
Failure
Press ENTER*

17. If you wish to create a new configuration based on your current one, save the current working memory to a V-Scanner folder, then edit the working memory with your changes. When you are finished with your edits, save your updated working memory to a new V-Scanner folder, leaving the V-Scanner folder with your original configuration intact. You may then use either your original configuration or the modified one.
18. Be sure to assign a name to each V-Scanner before you save it to a V-Scanner folder. You assign a V-Scanner name while using the configuration in working memory by pressing **PROG**, and then **FUNC, TEXT**. The text you enter here is stored in line 4 of the welcome message and saved with the contents of the V-Scanner when you write it to a folder.

You can use the V-Scanner feature to back up your work. Save your configuration to a V-Scanner folder after you make changes to a working memory configuration. If for any reason your scanner's working memory is accidentally altered or lost, you can recall the backup configuration data from the V-Scanner folder.

There will be an approximately 13 second pause after you select the desired V-Scanner and press **ENT** to confirm your

Beyond the Basics

choice when saving or loading V-Scanner data. During this period the scanner is transferring V-Scanner data to or from working memory.

using digital AGC

You may find that the audio level varies greatly among different users on digital systems that you monitor. Many analog conventional and trunked radio systems include components with automatic gain control to help normalize the audio levels of analog transmissions in the system. Digital radio systems typically do not include any automatic gain control functionality and tend to reproduce a user's voice audio signal more faithfully with regard to audio levels. This can result in a low level audio signal if a user on the system is not speaking close enough to their radio microphone. Your PRO-2096 features Digital AGC, which can compensate for these low audio levels when they occur. By default, Digital AGC is turned on. If desired, you can toggle the Digital AGC function on or off by pressing FUNC, and then MAN at any time. The display will briefly show *DSP AGC Off* or *DSP AGC On* accordingly. Digital AGC has no effect on analog transmissions. You may notice more background noise with Digital AGC on.

cloning programmed data

You can transfer the contents of the current scanner working memory to and from another PRO-2096 or PRO-96 scanner using an optional connecting cable with 1/8-inch (3.5 mm) phone plugs on both ends (use RadioShack part number 42-2420 available at your local RadioShack store), or to a computer application designed to work with this scanner using a PC interface cable (use RadioShack part number 20-289, available at your local RadioShack store).

Beyond the Basics

CLONE MODE Incorrect Model appears if the scanner receives data from a scanner other than a PRO-2096 and PRO-96. This scanner can send/receive the data to or from a PRO-96 scanner. Only the Light (PRO-96) and Dimmer (PRO-2096) settings are not transferred, they are set to default.

1. Turn on both scanners.
2. Connect the cable to each scanner's **PC/IF** jack. **CLONE MODE* UP to send, Remove Cable to Exit* appears on the display.
3. Press **▲** or **▼**. *Confirm send data? 1=YES Press other key for NO.* appears on the display.
4. Press **1** to send the data to the other unit or press any other key to cancel the operation.
5. The scanner sends the data. Do not disconnect the cable or interrupt power to either scanner while transferring data.
6. To exit clone mode, remove the cable.

cloning v-scanner data

Your scanner supports cloning of both working memory and V-Scanner memory to and from other PRO-2096 and PRO-96 scanners or PC application software. This section describes the process of cloning V-Scanner memory between two radios.

Two types of V-Scanner memory clone are supported. Full Clone transfers all V-Scanner folders from one PRO-2096 (the "source" radio) to a second PRO-2096 or PRO-96 (the "destination" radio). Selective Clone transfers selected V-Scanner folders from a "local" controlling radio to a "remote" slave radio.

Caution

The Full Clone feature should be used with caution – it overwrites all V-Scanner memory in the destination radio with the contents of the V-Scanner memory in the source

Beyond the Basics

radio. This operation cannot be undone.

full cloning

Do not disturb the source radio, destination radio or cable until the transfer is complete. Interrupting the transfer may result in corrupted data. Transferring all data will take approximately four minutes.

1. Identify the source and destination radios. Turn both radios on.
2. Connect the two radios using a male 1/8" to male 1/8" cloning cable. Both radios will show the clone mode display:
3. Press **PROG** on the source radio.
4. If you wish to replace the V-Scanner memory contents in the destination radio with the V-Scanner memory contents of the source radio, press **ENT** now. All eleven V-Scanner folders will be transferred from the source radio to the destination radio.
5. When the transfer is complete press **ENT** on the source radio and remove the cloning cable. Both radios restart.
6. Repeat steps 1-3 to clone multiple radios.

selective cloning

Selective cloning allows you to choose the specific source and destination folders within a local and remote radio. This feature should be used with caution – it overwrites the selected destination V-Scanner folder with the contents of the selected source V-Scanner folder. This operation cannot be undone.

1. Identify the local and remote radios. Turn both radios on.
2. On the local radio, press **PROG FUNC PROG** to enter V-Scanner menu, then press **SRCH**.

Beyond the Basics

3. Connect the two radios together using a male 1/8" phone plug to male 1/8" phone plug cloning cable. The local radio will handshake with the remote radio to prepare for the cloning session. During V-Scanner selective cloning operations, the local radio controls the session for both sending and receiving folders to and from the remote radio.
4. In addition to the two options indicated on the display, you can browse the V-Scanner contents on both radios simultaneously by pressing **SRCH** on the source radio. Press **CLEAR** to exit.
5. To send a V-Scanner folder from the local radio to the remote radio, press **▲**. Use **0-9** and **.** to select the source V-Scanner folder. The name of the source folder appears on the display. You can browse the V-Scanner contents by pressing **0-9** and **.** in succession until the desired folder is located. Press **▲** or **▼** to move between the source and destination folder fields. Use **0-9** and **.** to select the destination V-Scanner folder where you wish to store the sent data. Again, you may browse the V-Scanner contents on the remote scanner by pressing **0-9** and **.** until the desired folder is located. Once you have selected the desired source and destination folders, press **ENT** to send. You may abort the send operation by pressing **CLEAR**.
6. To receive a V-Scanner folder from the remote radio into the local radio, press the **▼** key. Use **0-9** and **.** to select the destination V-Scanner folder where you wish to store the received data. The name of the destination folder appears on the display. You can browse the local V-Scanner contents by pressing **0-9** and **.** in succession until the desired folder is located. Press **▲** or **▼** to move between the destination and source folder fields. Use **0-9** and **.** to select the source V-Scanner folder where you wish to store the sent data. Again, you may browse the V-Scanner contents on the remote scanner by pressing

Beyond the Basics

0-9 and **.** until the desired folder is located. Once you have selected the desired source and destination folders, press **ENT** to receive. You may abort the send operation by pressing **CLEAR**.

7. After data transfer is complete, you will be prompted to press **ENT**. This returns you to the main V-Scanner menu. To perform additional V-Scanner selective clone operations, press **SRCH** again. When finished, press **CLEAR** to exit and unplug the cloning cable from both radios.

Beyond the Basics

trunking operation

setting squelch for trunk scanning

For optimal receiver performance when scanning both trunked and conventional systems, we recommend that you set the squelch close to threshold. Navigate to a programmed channel in manual mode. While the channel is idle, turn the squelch control fully counterclockwise. You will hear a loud rushing noise from the speaker. Turn the squelch control clockwise until the noise stops. You may find it necessary to set the control a bit further in the clockwise direction to prevent very weak signals or interference from stopping the scan operation.

talkgroup ID hold

You can set your scanner to follow a trunking signal that you want to track during scanning.

1. While the scanner is stopped on a voice channel (*VC* appears), hold down **TRUNK** (or press and release **PAUSE**) until *ID hold ON* appears on the display.
2. To manually activate ID hold mode on a selected ID, enter the ID list, scroll to the desired ID, then press **FUNC TRUNK**. The scanner will initiate ID hold operation on the selected talkgroup.
3. When ID hold is activated and the scanner receives a voice channel, the scan indication *S* at the first digit in the top line changes to *H* to indicate that the call is being monitored while the scanner is in ID hold.
4. To release ID hold, press **SCAN**, **PAUSE**, or **TRUNK**.

turning an ID sub-bank on or off

1. Press **TRUNK** repeatedly to select the desired sub-bank.

Beyond the Basics

2. Press **FUNC 1** to toggle the sub-bank on or off. The on/off state of the sub-bank will appear in the scanner's display.

To turn the ID sub-bank on or off during the scan mode:

1. The channel storage bank must be set to Closed Mode to change the state of a sub-bank while scanning.
2. Press **FUNC** and then **TRUNK** while the scanner is stopped on a voice channel transmission. The bank text display is replaced with a sub-bank status display, *T IDbk 01234*. The flashing cursor indicates the current active sub-bank.
3. Press **FUNC** and the number of the sub-bank you wish to turn on or off (0-4). For example, to toggle sub-bank 4 on or off, press **FUNC**, then **4**.

open and closed mode operation

You can set your scanner to change the way it receives transmissions on Motorola, APCO-25 and EDACS trunked radio systems. These settings, called Open Mode and Closed Mode, control whether the scanner monitors all traffic from a trunked radio system, or only traffic from talkgroups you specify. Unlike the channel mode settings described above, Open/Close mode settings apply to a trunking system programmed into a single bank.

In Open Mode, you hear all active talkgroups except those you specifically exclude, making it easy to hear everything going on. In Closed Mode, you hear only those talkgroups you specify. This makes it easy to listen only to talkgroups you are interested in and exclude others.

Each scanner bank can be programmed with one trunked system. You can set each of the scanner's channel storage banks to Open or Closed Mode.

Conventional modes (AM, FM/Digital, CT and DC) are not affected by the Open/Closed Mode setting of a bank.

When you set a channel storage bank to Open Mode, +

Beyond the Basics

appears under the bank's number while scanning. When you set a channel storage bank to Closed Mode, - appears under the channel storage bank's number while scanning.

Traffic on locked out talkgroup IDs is ignored when the scanner is operating in Open and Closed Modes.

In Open Mode, the scanner will stop on all talkgroup traffic, except for traffic on talkgroups that are entered in the ID list and locked out. In Closed Mode, the scanner will only stop on talkgroup traffic if the ID is entered in the ID list and not locked out. Open Mode scanning is useful in cases where you wish to monitor all traffic on the trunked system, except for certain talkgroups which you specify by entering them into the ID list and locking them out. Open Mode scanning allows you to search the trunking system for new or previously unknown talkgroup activity while ignoring traffic on undesired talkgroups.

Closed Mode scanning is useful when you want to restrict monitoring to only the talkgroups you specified in the ID list.

tooggling open and closed modes

To toggle Open or Closed Mode state for a bank, press **FUNC**, **5** while stopped on a channel in the bank in SCAN, MAN or PGM modes. The scanner will briefly display *Bank OPEN* or *Bank CLOSED* to indicate the new Open or Closed state for the bank.

manual ID lockout toggle

1. Press **PROG**.
2. Press **TRUNK**.
3. Press **FUNC**, and then **▲** or **▼** to move to the desired bank.
4. Press **▲** or **▼** to select the ID memory.
5. Press **L/OUT** to toggle the lock out status of the selected ID.

Beyond the Basics

activate ID lockout while scanning

When scanning a trunked radio system in Open Mode, you can lock out a trunked ID by pressing **L/OUT** while the scanner is stopped on a voice call. If the ID has not been previously entered into the ID list for that bank, it will be added and locked out automatically. When scanning a trunked radio system in Closed Mode, it is possible to lock out an ID by pressing **L/OUT** while the ID is active with a voice call.

reviewing locked-out talkgroup IDs

You can easily review and clear locked talkgroup IDs in the ID list. This process is similar to finding and clearing locked out conventional channels, except it is performed while in a trunked ID list.

1. Press **PROG** and then **TRUNK**.
2. Press **FUNC**, and then **L/OUT**. The first locked out ID in the ID list is displayed.
3. Press **L/OUT** to unlock the selected ID, or press **FUNC**, and then **L/OUT** again to continue reviewing locked IDs.

changing from ID text tag display to ID code display

By default, your scanner displays the stored alphanumeric text tag when receiving a trunked voice call. You can toggle the display to show the text tag or the talkgroup ID code by pressing **TEXT** while the scanner is stopped on a trunked talkgroup call.

trunked delay function

The trunking ID delay is set separately from the channel delay on a per channel storage bank basis. Trunking ID delay specifies the amount of time the scanner dwells on the control channel looking for reply traffic on the previous

Beyond the Basics

talkgroup before resuming scan operation. Customizing the trunked ID delay may be useful if you are missing a lot of reply traffic on a particular system. We recommend starting with the default value of 2.0 seconds.

1. While in the desired ID list, press **FUNC**, and then **/DELAY**.
 2. Press **▲** or **▼** to select None, 0.5, 1.0, 1.5, 2.0, 2.5, 3.0, 3.5, or 4.0 seconds.
 3. Press **ENT**.
- Most Motorola trunking systems include a “hang time” where the channel remains assigned to a talkgroup for a short period after the user unkeys the microphone. This hang time is typically 1.5 seconds but can vary among different systems. The scanner’s trunked delay function begins after this hang time expires. Therefore, the total amount of delay present after a user unkeys the microphone equals the trunking system hang time, plus any trunked ID delay programmed into the scanner. For example, if you wish to wait a total of two seconds for a reply trunked call, and the system you are monitoring is using 1.5 seconds of hang time, you should set the trunked delay for that system to 0.5 seconds. EDACS systems do not employ hang time.
 - Conventional channel delay is fixed at 2 seconds and is controlled independently of trunked ID delay. Refer to “Using Delay” on Page 33 for more information.

clearing talkgroups IDs

You can clear IDs from the ID list to make room for new IDs.

1. Press **PROG** and then **TRUNK**.
2. Press **FUNC ▲** or **▼** to select an ID memory.
3. Press **FUNC** and then **CLEAR** to clear the contents of the selected ID.

Beyond the Basics

clearing all talkgroup IDs in one bank

You can clear all talkgroup IDs within a bank. This lets you quickly delete all talkgroup IDs from a bank if you want to use the bank to store different data (such as a new set of talkgroup IDs).

1. Press **PROG**.
2. Press **TRUNK** to enter a talk group ID memory mode.
3. Select a talkgroup ID bank using **FUNC**, **▲** or **▼**.
4. Press **FUNC**, **6**. *Confirm list clear? 1=YES Press other key for NO.* appears on the display.
5. Press **1** to clear all talkgroup IDs within a bank. *List cleared* appears in the scanner's display.

To cancel the delete operation, press any key except 1. The scanner returns to the talkgroup ID memory mode.

Beyond the Basics

programming trunked systems

If you are just getting started with trunked system monitoring or have any questions about how your PRO-2096 scanner operates when tracking trunked radio systems. For best results, program only one trunking system in each channel storage bank of your scanner. Your scanner will lock on to the first active control channel it finds in a channel storage bank and follow the activity from that trunking system.

Motorola analog, digital, and APCO-25 systems

1. Press **PROG** and **FUNC** then ▲ or ▼ to select the desired channel storage bank to program.
2. Press **TRUNK** to access the ID list and set the correct trunking bank type. If the bank has never been programmed with a trunking system, the scanner will display *Not trunked! Press mode.*
3. Press **MODE** until *Motorola* appears in the display. This sets the channel storage bank for Motorola operation.
4. Press **PROG** to return to the channel storage bank.
5. Select a channel to begin programming trunking system frequencies. Use direct channel entry or the ▲ or ▼.
6. Enter the trunking frequency and press **ENT**. If necessary, press **MODE** to change the receiving mode to MO (Motorola).
7. Repeat Steps 5 and 6 to enter the other trunking system control channel frequencies for the system you wish to monitor.

Notes

*You can also press **FUNC**, **TRUNK** to access the ID list from manual mode.*

When monitoring Motorola trunked radio systems, it is only necessary to program the trunking control channel.

Beyond the Basics

Notes

For APCO-25 trunking systems using the 9600 bps control channel, program the system using the steps outlined above for Motorola systems. Your scanner will automatically detect the proper control channel type.

Some systems rotate the control channel on a daily basis. For best results, program all known control channel frequencies into the trunking channel storage bank.

To program Motorola UHF trunking systems, see "Programming Motorola VHF and UHF Trunking Systems".

To program Motorola 800 MHz "splinter" systems, see "Programming Motorola 800 MHz Splinter Systems".

To program Motorola Type I/III fleet maps, see "Fleet Maps".

EDACS systems

You must program all EDACS system channels into your scanner in Logical Channel Number (LCN) order, beginning with LCN 1 in channel 01 of the channel storage bank. Do not program EDACS system channels in channel 00 of a channel storage bank. Refer to frequency publications or Internet sites to obtain correct LCN frequencies for the EDACS systems you wish to monitor. If the EDACS system you are programming skips channels in the LCN order, leave those channels blank in your scanner.

1. Press **PROG** and **FUNC**, and then ▲ or ▼ to select the desired channel storage bank to program.
2. Press **TRUNK** to access the ID list and set the correct trunking bank type. If the bank has never been programmed with a trunking system, *Not trunked! Press mode* appears.
3. Press **MODE** until *EDACS* appears. This sets the channel storage bank for EDACS operation.

Beyond the Basics

4. Press **PROG** to return to the channel storage bank.
5. Select a channel to begin programming trunking system frequencies. Use direct channel entry or the ▲ or ▼ keys.
6. Enter the trunking frequency and press **ENT**. If necessary, press **MODE** to change the receiving mode to ED.
7. Repeat Steps 5 and 6 to enter the other EDACS trunking system channels for the system you wish to monitor.

Motorola VHF and UHF systems

To monitor Motorola VHF and UHF systems, you must program the scanner with three additional parameters — the base frequency, step and offset.

1. Press **PROG**, and then **TRUNK** to enter the ID program mode.
2. Press **FUNC** and press (or hold) ▲ or ▼ to select the bank.
3. Press **MODE** until *Motorola* appears in the display.
4. Press **FUNC**, then **2**. The following appears:
*Base freq:
406.0000
Offset: 380
Step:25.0KHz*
5. While *B* in Base blinks, if necessary, enter the desired base frequency and press **ENT**.
6. While *O* in Offset blinks, if necessary, enter the offset number and press **ENT**.
7. While *S* in Step blinks, repeatedly press ▲ or ▼ to select the step number, 5, 6.25, 7.5, 12.5, 15, 25.0, or 50.0kHz, and then press **ENT**.

Notes

Base frequency, step and offset vary for each individual UHF trunking system. You can get information about these frequencies for the trunking system you want to scan using the Internet or locally published guidebooks.

- Systems with multiple channel ranges can be programmed

Beyond the Basics

using PC application software.

Motorola 800MHz splinter systems

Certain 800 MHz Motorola trunked radio systems operate using splinter channels that are in between the channels in the normal 800 MHz band plan. These systems are known as “splinter systems”. Your scanner features an offset mode to allow reception of these systems.

Note

If the radio appears to be trunking to the wrong frequencies when monitoring an 800 MHz system, you should try to configure the system for splinter operation.

Splinter systems exist only in the 800 MHz band, and only use the 3600 bps control channel type. Setting splinter configuration on VHF, UHF, 900 MHz and 800 MHz APCO-25 systems will have no effect.

1. Press **PROG, TRUNK** to enter ID program mode.
2. If necessary, press **FUNC**, and then ▲ or ▼ to select the desired bank.
3. If necessary, press **MODE** to select Motorola trunking mode.
4. Press **FUNC, 3** to edit 3600 CC Mode.
5. Press ▲ or ▼ to select Normal, Splinter, Table, or Multi Table, and then press **ENT**.

fleet maps

You must set the fleet map if you want to receive a Motorola Type I system. Fleet maps are included along with other information about Motorola Type I systems at www.trunkscanner.com. The default setting of the bank is for Motorola Type II.

1. Press **PROG, TRUNK**.
2. Press **FUNC**, and then ▲ or ▼ to select the desired bank.
3. Press **FUNC, 8**. Block 0 size code. Use 15 for type II. S-00 appears.

Beyond the Basics

4. Enter the size code supplied with the Type I system information, referring to the prompts that appear in your display. If the information for your Type I system is not available, try the fleet maps in the following tables.

Notes

If you set to receive Type I and later wish to restore Type II, enter 15 at Step 4.

5. To confirm your input, repeat Steps 1-4 and press **ENT**. Each time you press **ENT**, you confirm the size code. If you find an error, press **CLEAR** and start over.

Block	Size Code							
	1	2	3	4	5	6	7	8
0	S11	S4	S4	S12	S4	S3	S10	S1
1	S11	S4	S4	—	S4	S10	S10	S1
2	S11	S4	S4	S4	S12	S4	S11	S2
3	S11	S4	S4	S4	—	S4	S4	S2
4	S11	S4	S4	S4	S4	S12	S4	S3
5	S11	S4	S4	S4	S4	—	S4	S3
6	S11	S4	S12	S4	S4	S12	S4	S4
7	S11	S4	—	S4	S4	—	S4	S4

Block	Size Code							
	9	10	11	12	13	14	15	16
0	S4	S0	S4	S0	S3	S4	S4	S3
1	S4	S0	S0	S0	S3	S3	S4	S10
2	S0	S0	S0	S0	S11	S10	S4	S10
3	S0	S0	S0	S0	S4	S4	S11	S11
4	S0	S0	S0	S0	S4	S4	S11	S0
5	S0	S0	S0	S0	S0	S4	S0	S0
6	S0	S4	S0	S0	S0	S12	S12	S12
7	S0	S4	S0	S4	S0	—	—	—

Beyond the Basics

programming priority channels

With the priority feature, you can scan through programmed channels and still not miss an important or interesting transmission on the priority channel. When priority is turned on, the scanner checks the priority channel every two seconds, and stays on the priority channel if there is activity until the activity on that channel stops.

Notes

The priority feature does not work when the scanner receives a trunking voice channel or during trunking delay time. Traffic on the priority channel may be missed if it occurs while the scanner is monitoring a trunking voice call.

If you program a weather channel as the priority channel, and you activate priority mode, the scanner stops on the weather (priority) channel only when the scanner detects the 1050 Hz weather alert tone.

programming a stored channel frequency in the priority channel

1. Press **MAN**.
2. Use the number keys to enter the channel number that contains the frequency you want to program as the priority channel, and then press **MAN** again.
3. Press **FUNC**, and then **PRI**. *Pri Channel* blinks to indicate the current frequency is stored in priority channel memory.

programming the priority channel directly

1. Press **PROG**.
2. Press **PRI**.
3. Enter the frequency to store as the priority channel, then press **ENT**.

Beyond the Basics

4. If desired, set the priority channel mode. You can set a priority channel for CTCSS or DCS operation with a programmed code.

programming a weather channel as the priority channel

1. Press **WX**.
2. Press **WX** repeatedly until the desired weather channel you want to store as the priority channel appears.
3. Press **FUNC**, and then **PRI**. *Pri Channel* flashes two times.

turning priority on or off

Press **PRI** while scanning or manually parked on a channel. *PRI*on (or *PRI*wx if priority is set to a weather frequency) appears on the bottom of the display, and *P* appears on the top of the display. If the scanner detects activity on the priority channel, *Pri Channel* appears. If the scanner detects the 1050 Hz weather alert tone in Priority WX mode, *Weather ALERT* appears and an alert tone sounds. Press **WX** to listen to the weather alert message. To turn off priority, press **PRI**.

Notes

This scanner cannot set a channel as the priority channel if the channel's receive mode is MO or ED.

In the event of a weather or other hazard warning, a 1050 Hz tone is transmitted prior to the message. The scanner sounds an audible alert and switches to the weather frequency if the alert tone is detected.

Since this scanner does not priority sample the weather channel while monitoring trunked talkgroup calls, it is possible that the 1050 Hz alert tone may be missed between sample intervals when trunked systems are being scanned. We recommend the use of a dedicated RadioShack Weatheradio® during times when severe weather notification is critical for your safety.

Beyond the Basics

programming CTCSS/DCS channels

Your scanner features an advanced, DSP based CTCSS and DCS decoder. CTCSS and DCS allow you to program frequencies into your scanner that are used by more than one group in your area and listen only to the group that is of interest to you by specifying the group's specific CTCSS or DCS code. CTCSS and DCS can also help reduce interfering signals that cause your scanner to stop on one channel.

There are two ways you can program your scanner to operate with CTCSS and DCS. If you know the CTCSS or DCS code that is used on a particular frequency, you can manually enter the code when you are programming the scanner, or any time afterwards. You can also set a special search code that instantly decodes the CTCSS or DCS code on a received transmission. Channels programmed with the search code will receive all traffic on the channel, and will instantly decode and display any CTCSS or DCS code that is found with the transmission. You can then store the code in channel memory. For more information on using CTCSS and DCS while scanning, see "Using CTCSS and DCS".

1. Enter a conventional frequency.
2. Press **MODE** until the desired mode (*CT* for CTCSS, and *DC* for DCS) appears on the display.
3. By default, the search code is programmed. To program a specific code, press **FUNC**, **MODE**, and then use the arrow keys to scroll to the desired CTCSS or DCS code. You can also use the keypad to enter the code manually.
4. Once the desired code is selected, press **ENT** to store it in channel memory.
5. You can program memory channels for CTCSS or DCS operation at any time. Simply place the scanner in program mode, navigate to the channel you wish to

Beyond the Basics

change, and follow the steps above.

- When stopped on an active conventional channel while scanning, you can press **MODE** to cycle through the valid modes for that channel. This resets any stored CT or DC code to the search code, allowing you to easily check for other CT or DC codes that may be present on the frequency.

Notes

CTCSS, DCS, and digital voice all operate independently of each other. If a channel is configured for CTCSS or DCS, it will not be able to decode digital transmissions. Use FM mode when mixed analog and digital voice reception is desired.

CTCSS Code Table				
67.0 Hz	94.8 Hz	131.8 Hz	171.3 Hz	203.5 Hz
69.3 Hz	97.4 Hz	136.5 Hz	173.8 Hz	206.5 Hz
71.9 Hz	100.0 Hz	141.3 Hz	177.3 Hz	210.7 Hz
74.4 Hz	103.5 Hz	146.2 Hz	179.9 Hz	218.1 Hz
77.0 Hz	107.2 Hz	151.4 Hz	183.5 Hz	225.7 Hz
79.7 Hz	110.9 Hz	156.7 Hz	186.2 Hz	229.1 Hz
82.5 Hz	114.8 Hz	159.8 Hz	189.9 Hz	233.6 Hz
85.4 Hz	118.8 Hz	162.2 Hz	192.8 Hz	241.8 Hz
88.5 Hz	123.0 Hz	165.5 Hz	196.6 Hz	250.3 Hz
91.5 Hz	127.3 Hz	167.9 Hz	199.5 Hz	254.1 Hz

DCS Code Table								
6	50	125	174	255	343	445	526	703
7	51	131	205	261	346	446	532	712
15	53	132	212	263	351	452	546	723
17	54	134	214	265	356	454	565	731
21	65	141	223	266	364	455	606	732
23	71	143	225	271	365	462	612	734
25	72	145	226	274	371	464	624	743

Beyond the Basics

26	73	152	243	306	411	465	627	754
31	74	155	244	311	412	466	631	
32	114	156	245	315	413	503	632	
36	115	162	246	325	423	506	654	
43	116	165	251	331	431	516	662	
47	122	172	252	332	432	523	664	

storing talkgroup IDs

Each talkgroup on a trunked radio system is identified by a talkgroup ID. You can store talkgroup IDs automatically while scanning the trunked system in Open mode, or manually by entering the IDs directly.

To automatically store a talkgroup ID, press **TRUNK** when the scanner stops on a voice channel transmission or when a talkgroup ID is indicated in the manual mode. The ID of the active talkgroup is automatically stored in the next available ID memory location. Your scanner's display indicates where the ID was stored as *ID save X-YY*, and then changes to *ID#ZZZZ*, where *X* is the sub-bank number, *YY* is the ID number within the sub-bank, and *ZZZZ* is the stored talkgroup ID code. If the ID has already been stored when you press **TRUNK**, *ID was saved* appears on the scanner's display.

To manually store talkgroup IDs or to edit a stored ID:

1. Navigate to a channel in the desired trunking bank using **MAN**, **▲** or **▼**.
2. Press **PROG**.
3. Press **TRUNK**.
4. Select the ID memory you wish to edit using **MAN**, **▲** or **▼**.
5. Enter the talkgroup ID number and press **ENT**. If necessary, use the decimal point for a hyphen. If you make a mistake, *Invalid ID* appears and the scanner beeps when you press **ENT**. Start over again.

Beyond the Basics

Use the following keystrokes to navigate through the ID lists:

- Press **PROG, TRUNK** to enter the ID list for the current channel storage bank.
 - Press and release **▲** or **▼** to scroll through one at a time.
 - Press and hold **▲** or **▼** to rapidly scroll through ID memories.
 - Press **TRUNK** to advance to the next ID sub-bank.
 - Press **FUNC ▲** or **▼** to advance to the next or previous ID list.
6. If you want to tag the ID, press **TEXT**.
 7. Enter the desired text tag for the ID.
 8. Press **ENT**. (See "Text Input Chart").
 9. To store the next ID memory in sequence, press **▲** and repeat Step 5.
 10. Press **SCAN** to start scanning.

When automatically storing trunked IDs in the ID list by pressing **TRUNK** during a trunked transmission, the scanner automatically stores the active ID in the next available open ID storage location in the ID list. We suggest leaving ID sub-bank **0** empty when first setting up an ID list. This provides a location for new auto-store IDs to be placed and organized.

Notes

*You can enter either decimal or AFS code for ED (EDACS) ID. The default setting is decimal ID entry. To toggle between AFS or decimal EDACS ID display, press **FUNC, 2**. AFS format appears on the display for about two seconds. Now you can enter EDACS ID codes in AFS format.*

*If you entered an ID code that is already stored in another ID channel, Dupl ID appears. If you want to store the ID code anyway, press **ENT**. To cancel the operation, press **CLEAR**.*

When you try to store more than 150 talkgroup IDs in a bank, Memory full! appears on the display.

Beyond the Basics

text tags

assigning a text tag to a channel

1. Navigate to the channel you want to label using direct channel entry, ▲, ▼ or **FUNC** ▲ or ▼.
2. Press **PROG**. *M* in the display changes to *P* to indicate program mode.
3. Press **TEXT**. A cursor appears.
4. Enter the text using the number keys (see “Text Input Chart” on Page 69). If you make a mistake, press ▲ or ▼ to move to the character you want to change, press **CLEAR** to backspace and delete unwanted characters, or hold down **CLEAR** to abort the text entry. For example, to identify a channel as *FIRE Ch 6* (for Fire Channel 6):
 - F** is the third letter (of DEF) associated with 3 on the keypad. Press **3, 3**.
 - I** is the third letter (GHI) associated with 4 on the keypad. Press **4, 3**.
 - R** is the third letter (PQRS) associated with 7 on the keypad. Press **7, 3**.
 - E** is the second letter (DEF) associated with 3 on the keypad. Press **3, 2**.
Press **./DELAY** for the space.
 - C** is the third letter (ABC) associated with 2 on the keypad. Press **2, 3**.
 - h** is the second letter (GHI) associated with 4 on the keypad. Press **4**, and then **FUNC** (for the lower case set), and then press **2**.
Press **./DELAY** for the space.

Beyond the Basics

6 is the sixth number associated with 1 on the keypad.
Press **1, 6**.

5. Press **ENT** to store the text with the channel.

assigning a text tag to a group ID

1. Press **PROG**.
2. Press **TRUNK**.
3. Press **FUNC** then **▲** or **▼** to select the desired bank.
4. Press **TRUNK** to select the desired sub-bank.
5. Press or hold down **▲** or **▼** to select the desired group ID.
6. Press **TEXT**, then enter text using the number keys (see "Text Input Chart" on Page 69). Use **▲**, **▼** or **CLEAR** to edit your entry, or hold down **CLEAR** to delete the text entry.
7. Press **ENT** to store the text with the ID.

assigning a text tag to a channel-storage bank

1. Select a channel in the desired channel storage bank by pressing **MAN** and entering the channel storage bank number (**000** for bank 0 or **200** for bank 2). Press **MAN** again.
2. Press **PROG**.
3. Press **FUNC, 7**. A cursor appears on your display.
4. Enter the text using the keypad. (See "Text Input Chart"). Use **▲**, **▼** or **CLEAR** to edit your entry, or hold down **CLEAR** to delete the text entry.
5. Press **ENT** to store the text with the bank.

Beyond the Basics

text input chart

Press	Character	Press	Character
1	1 2 3 4 5 6 7 8 9 0		
2	A B C	2 FUNC	a b c
3	D E F	3 FUNC	d e f
4	G H I	4 FUNC	g h i
5	J K L	5 FUNC	j k l
6	M N O	6 FUNC	m n o
7	P Q R S	7 FUNC	p q r s
8	T U V	8 FUNC	t u v
9	W X Y Z	9 FUNC	w x y z
0	. - # _ @ + * & / ,	0 FUNC	\$ % ! ^ () ? -> ' <-
./DELAY	Space	CLEAR	Backspace

Notes

To enter a number, press 1. Then, press the desired number.

*To enter a lowercase character or a character from the second set for the key 0, press **FUNC** after pressing the first number key.*

using channel receive modes

You can program each channel with any one of six receive modes (AM, FM/Digital, CTCSS, DCS, Motorola, or EDACS).

Notes

Trunked modes (ED and MOT) can only be selected for frequencies above 137 MHz.

Closed Mode lets you hear transmissions from only those trunking talkgroups you specify. For more information, see "Open and Closed Mode Operation".

updating the DSP firmware

From time to time, improvements may be incorporated into the DSP firmware. These improvements are typically designed to address issues that may be present with decoding the digital audio signals, and audio quality

Beyond the Basics

improvements. With updateable DSP firmware, you can ensure that your scanner is using the most recent DSP version available. You can update the firmware for the DSP module by downloading a file from the Internet and transferring it to the scanner. To update your scanner's DSP firmware, you need:

- The supplied PC to scanner interface cable
- A personal computer running Windows 95 or greater
- A firmware update file from www.radioshack.com

1. Go to <http://www.radioshack.com>
2. Click on the **Product Manuals** tab.
3. Select **Software Downloads** from the drop down menu.
4. Click on **Software Updates and Downloads**.
5. Click on **PRO-2096 XXX.exe**. Full download and upgrade instructions are provided on the Firmware Upgrade page.
6. To check the DSP version number, turn on the scanner and press **3** while *Welcome to Digital Trunking* appears on the display. The version information appears.

troubleshooting

If you have problems with your scanner, please refer to the following for some suggestions that might help you eliminate the problem. If the scanner is still not operating correctly after trying these tips, take your scanner to your local RadioShack store for assistance.

Scanner is totally inoperative:

- Make sure the scanner is plugged into a working AC or DC outlet.
- Be sure the adapter's barrel plug is fully inserted into the DC 13.8V jack.

Beyond the Basics

Scanner will not scan when SCAN is pressed:

- Ensure that the scanner has more than one channel programmed and enabled for scanning.
- Adjust SQ properly.
- If the scanner is stopped on a frequency, tighten squelch, apply attenuator, or lock out the “birdie” frequency.
- The scanner may need to be reset or initialized. See “Resetting/Initializing the Scanner”.

Scanner does not receive digital transmissions on digital frequencies or trunking systems:

- The digital channel or talkgroup is not using APCO-25 digital modulation. The scanner can only receive APCO-25 C4FM IMBE digital signals.
- The digital channel or talkgroup is encrypted. The scanner will not receive encrypted traffic.
- The digital channel or talkgroup is being transmitted from a distant location. Reposition the scanner or use an outdoor antenna to improve reception.

resetting/initializing your scanner

If the scanner’s display locks up or does not work properly after you connect a power source, you might need to reset or initialize it. If you have problems with the scanner, first try resetting it, which will retain items stored in memory. If that does not work, initialize the scanner. You may be able to save the information in your scanner’s memory to your computer, a V-Scanner folder, or another scanner before initializing it. See “Cloning Programmed Data” on Page 45 and “Using V-Scanner”.

resetting your scanner

1. Turn off your scanner, and then turn it on again.

Beyond the Basics

2. Insert a pointed object into the reset hole on the back of the scanner. Then, gently press and release the reset button. Pressing reset does not clear the scanner's working memory or the V-Scanner folders.

initializing your scanner

Initializing your scanner clears all information stored in your scanner's working memory. Initialize your scanner only when you are sure it is not working properly. V-Scanner memory is not affected when you initialize the scanner.

1. Turn off the scanner, and turn it on again. First, the DSP boot version, and then *Welcome To Digital Trunking* appears.
2. Press **0**. The following messages appear on the display:
System Tests
Select Test
Exits if no
Key Press
3. Press **1**. The following messages appear on the display:
Factory Init
Erase Memory
ENTER if Yes
CL to EXIT
4. Press **ENT**. The following messages appear on the display:
Initializing
Clr Main Mem
V-Scan is OK
Please Wait
5. Do not turn off your scanner until the initialization is complete. When the initialization is complete, *M000* and *Bank 0 Ch 00* appear on the display.

Beyond the Basics

care

Keep the scanner dry; if it gets wet, wipe it dry immediately. Use and store the scanner only in normal temperature environments. Handle the scanner carefully; do not drop it. Keep the scanner away from dust and dirt, and wipe it with a damp cloth occasionally to keep it looking new.

replacing the fuse

First, turn off the scanner and your vehicle's ignition. Make sure you replace the fuse only with another fuse of the same type and rating (2-amp, fast-acting glass fuse).

service and repair

If your scanner is not performing as it should, take it to your local RadioShack store for assistance. To locate your nearest RadioShack, use the store locator feature on RadioShack's website (www.radioshack.com), or call 1-800-The Shack (800-843-7422) and follow the menu options. Modifying or tampering with the scanner's internal components can cause a malfunction and might invalidate its warranty and void your FCC authorization to operate it.

Beyond the Basics

specifications

Frequency Coverage

Frequency Range (MHz)	Programming/Search Step Value
25–54	5 kHz
108–136.9875	12.5 kHz
137–174	5, 6.25 or 7.5 kHz
216.0025–221.9975	5 kHz
222.0000 –225.0000	5 kHz
406–512	6.25 kHz
806–823.9875	6.25 kHz
849–868.9875	6.25 kHz
894–960	6.25 kHz
1240–1300	6.25 kHz

Memory Organization

V-Scanners	eleven 500 channel virtual scanners
Memory channels	500
Channel storage banks	10
Number of channels per channel storage bank	50
Talkgroup ID memories	1500
ID memory banks	10
Sub-banks per bank	5
Number of memory IDs per sub-bank	30

Sensitivity (20 dB S/N)

FM:

25–54 MHz	0.3 μ V
108–136.9875 MHz	0.3 μ V

Beyond the Basics

137–174 MHz	0.5 μ V
216–225 MHz	0.5 μ V
406–512 MHz	0.5 μ V
806–960 MHz	0.7 μ V
1240–1300 MHz	0.7 μ V

AM:

25–54 MHz	1 μ V
108–136.9875 MHz	1 μ V
137–174 MHz	1.5 μ V
216–225 MHz	1.5 μ V
406–512 MHz	2 μ V
806–960 MHz	2 μ V
1240–1300 MHz	3 μ V

Selectivity

25 – 27.995 MHz in AM mode

–6 dB	\pm 5 kHz
–50 dB	\pm 6 kHz
All frequencies at AM and FM mode except 25 – 27.995 MHz at AM	
–6 dB	\pm 8 kHz
–50 dB	\pm 14 kHz

IF Rejection

380.8 MHz at 174 MHz.....	60 dB
21.4 MHz at 174 MHz.....	100 dB

Spurious Rejection

at 174 MHz FM.....	40 dB
--------------------	-------

Scanning Speed and Delay

Scanning Rate.....	Up to 60 channels per second
--------------------	------------------------------

Beyond the Basics

Search Rate.....	Up to 75 steps per second
Conventional Channel Delay Time	2 seconds
Priority Sampling.....	2 seconds
Trunking Talkgroup Delay Time	User configurable

Intermediate Frequencies (IF)

1st.....	380.7275 to 380.86875 MHz
2nd	21.4 MHz
3rd	455 kHz

Squelch Sensitivity

Threshold (FM and AM)	0.5 μ V
Tight (FM)	25 dB
Tight (AM).....	20 dB
Antenna Impedance	50 Ohms
Audio Output Power (10% THD)	1.5 W
Built-in Speaker	3 in. (77 mm) 8-ohm dynamic type
Power Requirement.....	13.8 V
Current Drain	600 mA
Physical Dimensions (HWD)	$2\frac{1}{4} \times 7\frac{1}{4} \times 5\frac{5}{16}$ inches (55 x 185 x 135 mm)
Weight (without cabinet and accessories)	27.7 oz. (790 g)
Operating Temperature	-4 to 140°F (-20 to 60°C)

Specifications are typical: individual units might vary. Specifications are subject to change and improvement without notice.

Beyond the Basics

The FCC wants you to know

This equipment has been tested and found to comply with the limits for a scanning receiver, pursuant to Part 15 of the *FCC Rules*. These limits are designed to provide reasonable protection against harmful interference in a residential installation. This equipment generates, uses and can radiate radio frequency energy and, if not installed and used in accordance with the instructions, may cause harmful interference to radio communications.

However, there is no guarantee that interference will not occur in a particular installation. If this equipment does cause harmful interference to radio or television reception, which can be determined by turning the equipment off and on, the user is encouraged to try to correct the interference by one or more of the following measures:

- Reorient or relocate the receiving antenna.
- Increase the separation between the equipment and receiver.
- Connect the equipment into an outlet on a circuit different from that to which the receiver is connected.

scanning legally

Your scanner covers frequencies used by many different groups including police and fire departments, ambulance services, government agencies, private companies, amateur radio services, military operations, pager services, and wireline (telephone and telegraph) service providers. It is legal to listen to almost every transmission your scanner can receive. However, there are some transmissions you should never intentionally listen to. These include:

- Telephone conversations (cellular, cordless, or other private means of telephone signal transmission)
- Pager transmissions
- Any scrambled or encrypted transmissions

According to the Electronic Communications Privacy Act (ECPA), you are subject to fines and possible imprisonment for intentionally listening to, using, or divulging the contents of such a transmission unless you have the consent of a party to the communication (unless such activity is otherwise illegal).

This scanner has been designed to prevent reception of illegal transmissions. This is done to comply with the legal requirement that scanners be manufactured so as to not be easily modifiable to pick up those transmissions. Do not open your scanner's case to make any modifications that could allow it to pick up transmissions that are illegal to monitor. Doing so could subject you to legal penalties.

In some areas, mobile use of this scanner is unlawful or requires a permit. Check the laws in your area. It is also illegal in many areas to interfere with the duties of public safety officials by traveling to the scene of an incident without authorization.

We encourage responsible, safe and legal scanner use.

Beyond the Basics

glossary

Channels – programmable memory locations for frequencies you want to monitor. Each time the scanner finds an active frequency, it stops and monitors radio traffic on that channel until the transmission ends. It then resumes scanning.

Channel-Storage Bank – storage area for a group of channels. Channels are storage locations for frequencies. You can scan the channel-storage banks to see if there is activity on frequencies stored there. Whereas a channel can only contain one frequency, a channel storage bank can hold up to 50 channels. To make it easier to identify and select the channels you want to listen to, your scanner divides the channels into 10 banks (0 to 9) of 50 (00 to 49) channels each, for a total of 500 channels. You can use each channel-storage bank to group frequencies, such as those used by different public safety agencies and jurisdictions in your area. Channel storage banks can easily be enabled or disabled while scanning by pressing the number key that corresponds to the desired channel storage bank.

Digital Operation – Your scanner is equipped with advanced Digital Signal Processing circuitry to receive and decode Phase 1 APCO-25 C4FM (four level FM) digital voice transmissions. This section of the manual will help you understand the differences between traditional analog and digital modulation. For ease of use, your scanner is designed to automatically detect digital modulation on any conventional channel programmed for FM/Digital (FM) modulation. It is not necessary to configure individual channels for digital operation. Many digital trunked radio systems are actually mixed mode systems that support both analog and digital modulation. Certain user groups on these systems may use analog modulation, while others use digital modulation. Your scanner will automatically detect the type of modulation being used and switch to the correct modulation mode without special programming or user intervention. Your scanner also features Intelligent Adaptive Digital Tracking for optimal reception of digital signals from a variety of digital conventional and trunked radio system types. No special sound quality settings or adjustments are needed for different C4FM system types. Digital modulation represents a breakthrough in

Beyond the Basics

public safety communications technology. Digital modulation typically provides a clear distortion free audio signal throughout the service area of the system you are monitoring. However, there are some important differences between analog and digital voice performance that you should be aware of while scanning. In most cases, digital voice transmissions will be surprisingly crisp and clear, and without noise or distortion, even when corresponding analog signals from the same system contain some static. However, if you are in a location with marginal reception, you may find that the voice quality of digital signals deteriorates very rapidly, resulting in missing syllables or entire words. If this happens, try reorienting the scanner or antenna for better reception. You may also try pressing the ATT key and apply attenuation to reduce the overload effects of nearby strong transmitters. Under certain very weak digital signal conditions, the scanner may lose synchronization with the digital signal and briefly revert to analog FM, resulting in the reception of the raw, undecoded digital signal. This is a normal indication of a digital signal that is too weak to decode.

Frequency – the receiving signal location (expressed in MHz). To find active frequencies, you can use frequency guides available from your local RadioShack store, frequency listings posted on the Internet, or the built-in search function.

Search Banks – contain preprogrammed frequencies in the scanner's memory. Your scanner has six preprogrammed search banks configured to search various radio services, and one limit search bank that you can configure. You can set the lower and higher frequency limit in the limit search bank. For example, if you wanted to find active frequencies between a range of 150.1000 and 150.5000, you would put both of those frequencies in the limit search bank. You can even change the frequency range in a search bank (SR6) to customize your search parameters.

Talkgroup IDs – Each channel storage bank has an associated talkgroup ID list, for a total of 10 talkgroup ID lists. Each ID list has five sub-banks. Each sub-bank has 30 ID locations. You can program up to 150 talkgroup IDs in each bank, so you can program up to 1500 talkgroup IDs in ten banks. When the scanner stops on a transmission in Motorola or EDACS mode, it checks

Beyond the Basics

to see if the ID is stored in the associated ID list. In Closed Mode, the scanner only stops on the transmission and displays its text tag if the ID is stored and not locked out. In Open Mode, the scanner stops on all transmissions except those you specifically lock out, and the ID's text tag appears if the ID is stored.

V-Scanner – contains a complete, stored configuration profile of your scanner's programming. V-scanner lets you store or recall up to 11 scanner configurations in folders on your scanner, without using a personal computer. You can use V-Scanner to build and store configurations for different areas or different scanner applications. You can use the cloning feature to exchange scanner configurations with your friends without losing your existing data. V-Scanner also lets you back up your programmed data without connecting your scanner to a personal computer. Each V-Scanner folder stores all channel storage banks, channels, trunking IDs, search settings, and other parameters associated with scanner operation.

AM Mode (AM) – sets the scanner to receive amplitude modulation (AM) transmissions. AM is primarily used for aircraft, military, 27 MHz citizen's band, some amateur radio, and some government transmissions.

FM/Digital Mode (FM) – sets the scanner to receive FM/Digital (FM) transmissions using frequency modulation (FM) and APCO-25 digital modulation. FM is used for most public safety transmissions, as well as broadcast, business, and amateur radio transmissions.

CTCSS Mode (CT) – sets the scanner to receive transmissions using frequency modulation (FM) with Continuous Tone Coded Squelch System (CTCSS) subaudible tone codes. CTCSS allows multiple users to share a single radio frequency without hearing each other's transmissions.

DCS Mode (DC) – sets the scanner to receive transmissions using frequency modulation (FM) with Digital Coded Squelch (DCS) subaudible data signaling.

Motorola/APCO-25 Trunking Mode (MO) – You can set your scanner so it decodes talkgroup IDs used with Motorola and APCO-25 trunking systems, and follows talkgroup calls in the trunking system. This setting is called Motorola mode.

Beyond the Basics

EDACS Trunking Mode (ED) – You can set your scanner so it decodes talkgroup IDs used with EDACS (GE/Ericsson/M/ACOM) trunking systems. This setting is called the EDACS mode. EDACS systems are used primarily by business or private communications service providers, as well as by some public safety organizations.

Beyond the Basics

Beyond the Basics

RadioShack.

limited one-year warranty

This product is warranted by RadioShack against manufacturing defects in material and workmanship under normal use for one (1) year from the date of purchase from RadioShack company-owned stores and authorized RadioShack franchisees and dealers. For complete warranty details and exclusions, check with your local RadioShack store.

RadioShack Customer Relations
200 Taylor Street, 6th Floor, Fort Worth, TX 76102

04/04

GE-04D-2030
Printed in Hong
Kong33
20-496



©2004. RadioShack Corporation.
All rights reserved. RadioShack and RadioShack.com are
trademarks used by RadioShack Corporation.